

FAX Option Type 3045

Operating Instructions Facsimile Reference <Basic Features>



-
- 1** Getting Started
 - 2** Faxing
 - 3** Using Internet Fax Functions
 - 4** Programming
 - 5** Troubleshooting

Introduction

This manual contains detailed instructions and notes on the operation and use of this machine. For your safety and benefit, read this manual carefully before using the machine. Keep this manual in a handy place for quick reference.

Notes

Some illustrations in this manual might be slightly different from the machine.

Certain options might not be available in some countries. For details, please contact your local dealer.

Two kinds of size notation are employed in this manual. With this machine refer to the metric version.

Important

Contents of this manual are subject to change without prior notice. In no event will the company be liable for direct, indirect, special, incidental, or consequential damages as a result of handling or operating the machine.

Trademarks

Microsoft® and Outlook® are either registered trademarks or trademarks of Microsoft Corporation in the United States and/or other countries.

Adobe® and Acrobat® are registered trademarks of Adobe Systems Incorporated.

Other product names used herein are for identification purposes only and might be trademarks of their respective companies. We disclaim any and all rights to those marks.

Manuals for This Machine

The following manuals describe the operational procedures of this machine. For particular functions, see the relevant parts of the manual.

Note

- Manuals provided are specific to machine type.
- Adobe Acrobat Reader/Adobe Reader is necessary to view the manuals as a PDF file.
- Two CD-ROMs are provided:
 - CD-ROM 1 “Operating Instructions”
 - CD-ROM 2 “Scanner Driver and Document Management Utility”

❖ **General Settings Guide (PDF file - CD-ROM 1)**

Provides an overview of the machine and describes System Settings (such as Tray Paper Settings), Document Server functions, and troubleshooting. Refer to this manual for Address Book procedures such as registering fax numbers, e-mail addresses, and user codes.

❖ **Security Reference**

This manual is for administrators of this machine. It describes security functions that the administrators can use to protect data from being tampered with, or prevent the machine from unauthorized use. Also refer to this manual for the procedures for registering administrators, as well as setting user and administrator authentication.

❖ **Network Guide (PDF file - CD-ROM 1)**

Provides information about configuring and operating the printer in a network environment and using software. This manual covers all models, and therefore contains functions and settings that may not be available for your model. Images, illustrations, functions, and supported operating systems may differ from those of your model.

❖ **Copy Reference (PDF file - CD-ROM 1)**

Describes operations, functions, and troubleshooting for the machine’s copier function.

❖ **Facsimile Reference <Basic Features> (this manual) (PDF file - CD-ROM 1)**

Describes operations, functions, and troubleshooting for the machine’s facsimile function.

❖ **Facsimile Reference <Advanced Features> (PDF file - CD-ROM 1)**

Describes advanced facsimile functions such as line settings and procedures for registering IDs.

❖ **Printer Reference (PDF file - CD-ROM 1)**

Describes system settings, operations, functions, and trouble shooting for the machine's printer function.

❖ **Scanner Reference (PDF file - CD-ROM 1)**

Describes operations, functions, and troubleshooting for the machine's scanner function.

❖ **Manuals for DeskTopBinder Lite**

DeskTopBinder Lite is a utility included on the CD-ROM labeled "Scanner Driver and Document Management Utility".

- DeskTopBinder Lite Setup Guide (PDF file - CD-ROM 2)
Describes installation of, and the operating environment for DeskTopBinder Lite in detail. This guide can be displayed from the **[Setup]** dialog box when DeskTopBinder Lite is installed.
- DeskTopBinder Introduction Guide (PDF file - CD-ROM 2)
Describes operations of DeskTopBinder Lite and provides an overview of its functions. This guide is added to the **[Start]** menu when DeskTopBinder Lite is installed.
- Auto Document Link Guide (PDF file - CD-ROM 2)
Describes operations and functions of Auto Document Link installed with DeskTopBinder Lite. This guide is added to the **[Start]** menu when DeskTopBinder Lite is installed.

❖ **Other manuals**

- PostScript 3 Supplement (PDF file - CD-ROM 1)
- Unix Supplement (Available from an authorized dealer, or as a PDF file on our Web site.)

 **Note**

☐ The following software products are referred to using a general names:

- DeskTopBinder Lite and DeskTopBinder Professional → DeskTopBinder
- ScanRouter V2 Lite and ScanRouter EX Professional (optional) → the ScanRouter delivery software
- SmartDeviceMonitor for Admin and SmartDeviceMonitor for Client → SmartDeviceMonitor for Admin/Client

TABLE OF CONTENTS

Manuals for This Machine	i
How to Read This Manual	1
Symbols	1
Names of Major Functions	2

1. Getting Started

Control Panel	3
Reading the Display	5
Reading the display panel and using keys	6
User Authentication	8
User Code Authentication (using the control panel)	8
User Code Authentication (using a printer driver)	8
Login (using the control panel)	8
Log off (using the control panel)	9
Login (using a printer driver).....	9
Login (using a Web browser).....	9
Log off (using a Web browser)	9

2. Faxing

Placing Originals	11
Setting a Scan Area	13
Transmission Modes	16
Switching between Memory Transmission and Immediate Transmission.....	16
Memory Transmission	17
Canceling a Memory Transmission	21
Before the Original Is Scanned	21
While the Original Is Being Scanned.....	21
While the Original Is Being Transmitted	21
Before the Transmission Is Started	22
Immediate Transmission	24
Canceling an Immediate Transmission	26
Before You Have Pressed the [Start] Key	26
After You Have Pressed the [Start] Key	26
Confirming Transmission	27
Confirming on Display	27
Confirming by Report	27
Memory Transmission	27
Immediate Transmission	27
Confirming by E-mail	27
Confirming by Report and E-mail	28
Communication Result Report (Memory Transmission)	28
Immediate TX Result Report (Immediate Transmission)	29

Scan Settings	30
Resolution	30
Original Type	31
Image Density (Contrast)	32
Mixing Scan Settings for a Multiple Page Original	33
When placing originals on the exposure glass	33
When placing originals in the optional Auto Document Feeder (ADF)	34
Specifying a Destination	35
Entering a Fax Number	35
Pause	36
Tone	36
Entering an E-mail Address	37
When bypassing the SMTP server	38
Entering an IP-Fax Destination	38
Registering Entered Destinations to the Address Book	40
Using the Destination List to Specify Single or Group Destinations.....	41
Searching for a Destination	44
Search by Destination Name	44
Search by Fax Number	45
Search by E-mail Address.....	46
Search by IP-Fax Destination	47
Search by LDAP Server	48
Specifying a Registration Number.....	50
Reception	52
Switching the Reception Mode.....	52
Receiving a Fax in Manual Reception Mode.....	53
3. Using Internet Fax Functions	
<hr/>	
Internet Fax Functions (by Specifying an E-mail Address)	55
Internet Fax Precautions	56
Functions Not Supported by E-mail Transmission	57
Functions Not Supported by E-mail Reception	57
T.37 Full Mode	57
Sending Internet Fax Documents	59
Bypassing the SMTP Server.....	66
Confirming Reception.....	67
Canceling Transmission of an Internet Fax	68
Before the Original Is Scanned	68
While the Original Is Being Scanned.....	68
After the Original Is Scanned	69
Receiving Internet Fax Documents	70
Auto E-mail Reception	70
Manual E-mail Reception	71
Received Images	72
Internet Fax Functions (by Specifying an IP Address)	73
Notes on Using IP-Fax	75
Functions Not Available for IP-Fax Transmission	75
Sending by IP-Fax	76

4. Programming

Initial Settings and Adjustments	79
Programming.....	80
Editing	82
Deleting	83
Programming Destinations in the Address Book	85

5. Troubleshooting

Adjusting the Volume	87
When the [Facsimile] Key Is Lit in Red.....	89
When Toner Runs Out.....	90
Error Messages and Their Meanings	91
Solving Problems.....	97
When Things Don't Go as Expected	101
INDEX.....	102

How to Read This Manual

Symbols

In this manual, the following symbols are used:

 **WARNING:**

This symbol indicates a potentially hazardous situation that might result in death or serious injury if you misuse the machine without following the instructions under this symbol. Be sure to read the instructions, all of which are included in "Safety Information", *General Settings Guide*.

 **CAUTION:**

This symbol indicates a potentially hazardous situation that might result in minor or moderate injury or property damage that does not involve personal injury if you misuse the machine without following the instructions under this symbol. Be sure to read the instructions, all of which are included in "Safety Information", *General Settings Guide*.

* The statements above are notes for your safety.

 **Important**

If this instruction is not followed, paper might be misfed, originals might be damaged, or data might be lost. Be sure to read this.

 **Preparation**

This symbol indicates information or preparations required prior to operating.

 **Note**

This symbol indicates precautions for operation, or actions to take after abnormal operation.

 **Limitation**

This symbol indicates numerical limits, functions that cannot be used together, or conditions under which a particular function cannot be used.

 **Reference**

This symbol indicates a reference.

[]

Keys that appear on the machine's display panel.

[]

Keys and buttons that appear on the computer's display.

[]

Keys built into the machine's control panel.

Names of Major Functions

This machine's major functions are referred to in this manual as follows:

- Internet Fax (by specifying an e-mail address) → Internet Fax
- Internet Fax (by specifying an IP address) → IP-Fax

1. Getting Started

Control Panel

The actual machine control panel may differ from this illustration depending on installed optional units. This illustration has all options installed.

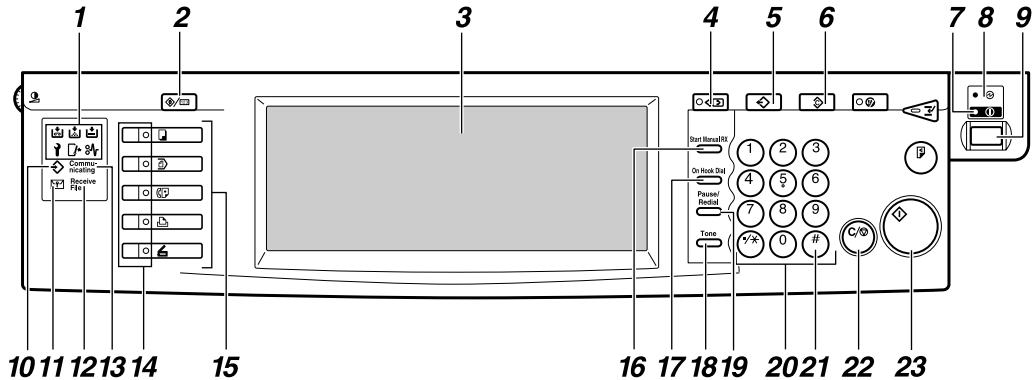

AJA001S

1. Indicators

Shows errors and machine status.

: Service Call indicator

: Misfeed indicator

: Open Cover indicator

: Add Staple indicator

: Add Toner indicator

: Paper run-out indicator

See "Control Panel", *General Settings Guide*.

2. [User Tools/Counter] key

User Tools:

Press to enter User Tools mode. These tools allow you to customize default settings. See p.141 "Facsimile Features", *Facsimile Reference <Advanced Features>*.

Counter:

Displays and prints the total number of copied or printed pages.

3. Display Panel

This guides you through tasks and displays the machine status. Messages appear here. See p.5 "Reading the Display".

4. [Check Modes] key

Press before pressing the **[Start]** key to check the settings selected for the fax about to be sent. See p.20 "Checking the transmission settings".

5. [Program] key

Enables you to program frequently used settings and recall previously programmed settings. See p.129 "Programs", *Facsimile Reference <Advanced Features>*.

6. [Clear Modes] key

Press to cancel the current settings.

7. On indicator

This indicator lights when the operation switch is turned on.

Important

- Do not turn off the main power switch while the On indicator stays lighted or is blinking. Neglecting this may damage the hard disk.

Note

- If the main power switch is on even when the On indicator is off, the machine will receive a fax document.

8. Main power indicator

This indicator lights when the main power switch is turned on. See "Turning On the Power", *General Settings Guide*.

9. Operation switch

Press to turn the power on (the On indicator lights). To turn the power off, press this switch again (the On indicator goes off). See p.202 "Turning Off the Main Power / In the Event of Power Failure", *Facsimile Reference <Advanced Features>* .

Note

- The Operation switch does not function when the [User Tools / Counter / Inquiry] display is shown.

10. ↔ Data In indicator

Blinks when transmission, printing, storing to Document Server are performed with using the LAN-Fax Driver.

11. Confidential file indicator

Lights when a document is received into memory with Confidential Reception or Personal Box. See p.41 "Printing Personal Box Documents", *Facsimile Reference <Advanced Features>* .

Blinks when a Memory Lock file is received into memory. See p.38 "Printing a File Received with Memory Lock", *Facsimile Reference <Advanced Features>* .

12. Receive File indicator

Lights when a document other than a Confidential Reception or Memory Lock file is received. See p.85 "Substitute Reception", *Facsimile Reference <Advanced Features>* .

Also lights when a document is received if the Reception Setting is set to Store. See p.195 "Storing or Printing Received Documents", *Facsimile Reference <Advanced Features>* .

13. Communicating indicator

Lights during transmission or reception.

14. Function status indicators

- When lit green, the corresponding function is active.
- When lit red, the corresponding function is interrupted. Press the respective key, and then follow the instructions that appear on the screen.

15. Function keys

Press the [Copy], [Document Server], [Facsimile], [Printer], or [Scanner] key to activate the respective function. The display content changes accordingly.

The indicator for the selected function lights up.

16. [Start Manual RX] key

Press when Manual Reception is set. See p.53 "Receiving a Fax in Manual Reception Mode".

17. [On Hook Dial] key

Press to dial while listening to the speaker tone. See p.57 "On Hook Dial", *Facsimile Reference <Advanced Features>* .

18. [Tone] key

Press to send tonal signals down a pulse dialing line. See p.36 "Tone".

19. [Pause/Redial] key

Pause:

Inserts a pause when you are dialing or storing a fax number. A pause cannot be inserted as the first digit. See p.36 "Pause".

Redial:

Press to redial one of the last ten numbers. See p.47 "Redial", *Facsimile Reference <Advanced Features>* .

20. Number keys

Use to dial fax numbers, or enter the number of copies.

21. [#] key (Enter key)

Registers entered contents or settings.

22. [Clear/Stop] key

Clear:

Cancels entered numbers or characters.

Stop:

Interrupts the current operation (transmission, scanning, copying, or printing).

23. **[Start]** key



Press to start faxing, or printing reports, or lists.

Reading the Display

The display guides you through operations, shows messages, machine status, and destinations registered in the destination lists. See “Fax Destination”, *General Settings Guide*.

If you press the **[Facsimile]** or **[Clear Mode]** key during operation, this machine enters fax standby mode.

Each function name displayed acts as a selection key, which you can touch to select or specify the function.

When a function is selected or specified, the function name is highlighted like this . When a function cannot be selected or specified, the function name is grayed out like this .

Note

- This machine automatically returns to standby mode if you do not use the machine for a certain period of time. You can select the period using the Facsimile Auto Reset Timer. See “Timer Settings”, *General Settings Guide*.
- You can have the machine return to default mode after each transmission using **[Scan End Reset]** under Gen. Settings/ Adjust. See p.145 “General Settings/Adjustment”, *Facsimile Reference <Advanced Features>*.

Reading the display panel and using keys

Display contents will differ depending on installed optional units.

❖ Initial Display

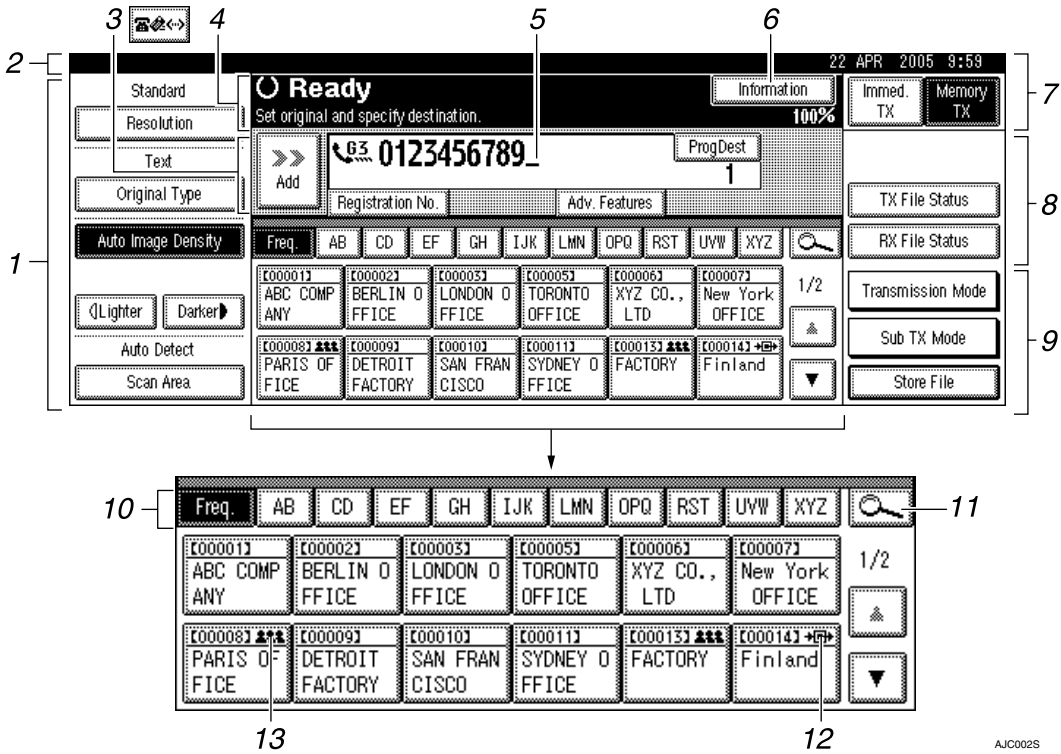

1. Allows you to select scanning conditions and sizes.

2. Displays the date and time, the name and facsimile number of a destination when transmitting, and the size of the original.

When user authentication is set, a login user name appears.

3. Press this button to enter or add fax numbers, e-mail address, or IP-Fax number.

- Internet Fax setting "On":
- IP-Fax, H.323, SIP setting "On":
- Internet Fax setting "On" and IP-Fax, H.323, SIP setting "On":

Note

- To use the Internet Fax or IP-Fax function, the optional printer/scanner unit is required.
- You can change Internet Fax setting under E-mail Settings in the Facsimile Features menu. See p.148 "E-mail Settings", *Facsimile Reference <Advanced Features>* .
- You can change IP-Fax settings under IP-Fax Settings in the Facsimile Features menu. See p.150 "IP-Fax Settings", *Facsimile Reference <Advanced Features>* .

4. Displays messages and the machine status.
5. Displays the entered number of a destination. When adding destinations using the number keys, press **[Add]**.
6. Press to display various information about transmission.
7. Switches transmission mode between Memory Transmission and Immediate Transmission. See p.16 "Switching between Memory Transmission and Immediate Transmission".
8. Displays Quick Operation keys set for frequently used functions. **[TX File Status]** and **[RX File Status]** are preset. See p.145 "General Settings/Adjustment", *Facsimile Reference <Advanced Features>* .
9. Displays various sending functions. See p.16 "Transmission Modes", p.62 "Sub Transmission Mode", *Facsimile Reference <Advanced Features>* , p.134 "Storing a Document", *Facsimile Reference <Advanced Features>* .
10. Title word keys appear. Allows you to switch from one page (display) to another on the destination list. See p.42 "Switching the titles of destination lists".
11. Allows you to search for a destination by destination name, fax number, e-mail address or registration number.
12. Appears on Destination keys programmed as a transfer station.
13. Appears on Destination keys programmed with a group of destinations. See "Registering Names to a Group", *General Settings Guide*.

❖ **To return to standby mode, do one of the following:**

- If you have placed the original in the optional Auto Document Feeder (ADF) and have not pressed the **[Start]** key, remove the original.
- If you have not placed an original, press the **[Clear Modes]** key.
- If you are in User Tools mode, press the **[User Tools/Counter]** key.

User Authentication

If user authentication (User Code Authentication, Basic Authentication, Windows Authentication, LDAP Authentication, or Integration Server Authentication) is set, the authentication screen is displayed. Unless a valid user name and password are entered, operations are not possible with the machine. Log on to operate the machine, and log off when you finish operations. Be sure to log off to prevent unauthorized users from using the machine.

 **Note**

- ❑ Consult the user administrator about your login user name, password, and user code. For details about the various types of user authentication, consult the appropriate administrators.
- ❑ For user code authentication, enter a number that is registered in the Address Book as a login user name.

User Code Authentication (using the control panel)

When user authentication is set, the following screen appears.

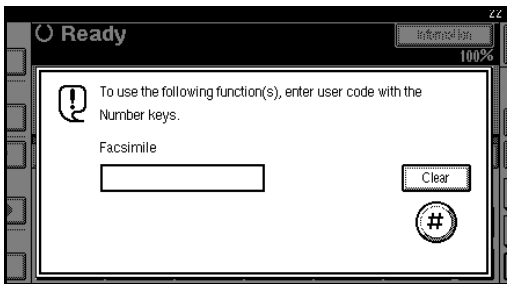

Enter a user code (eight digits), and then press [#].

User Code Authentication (using a printer driver)

If user authentication is set, specify the user code in the printer properties of a printer driver. For details, see the printer driver Help.

Login (using the control panel)

Use the following procedure to log in when Basic Authentication, Windows Authentication, LDAP Authentication, or Integration Server Authentication is set.

1 Press [Enter] for [Login User Name].

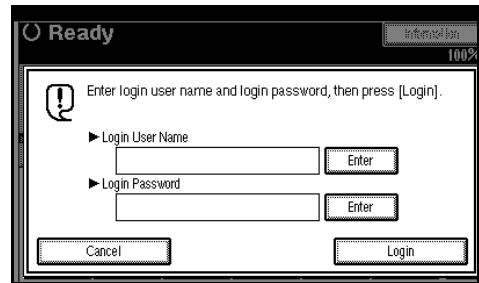

2 Enter a login user name, and then press [OK].

3 Press [Enter] for [Login Password].

4 Enter a login password, and then press [OK].

5 Press [Login].

When the user is authenticated, the screen for the function you are using appears.

Log off (using the control panel)

Use the following procedure to log off when Basic Authentication, Windows Authentication, LDAP Authentication, or Integration Server Authentication is set.

1 Press the **[User Tools/Counter]** key.

2 Press **[Logout]**.

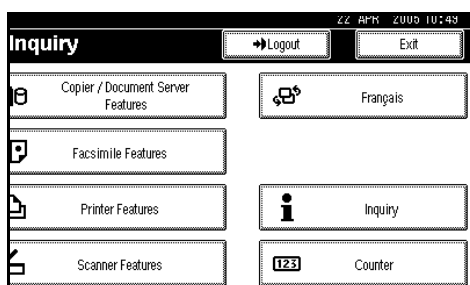

3 Press **[Yes]**.

4 Press the **[User Tools/Counter]** key.

Login (using a printer driver)

If Basic Authentication, Windows Authentication, LDAP Authentication, or Integration Server Authentication is set, make encryption settings in the printer properties of a printer driver, and then specify a login user name and password. For details, see the printer driver Help.

Note

- When logged on using a printer driver, logging off is not required.

Login (using a Web browser)

Use the following procedure to log on when user authentication is set.

Note

- It is recommended that you use a Web Image Monitor running under the same network environment as this machine. Otherwise, the Web browser may not open and an error may occur.

1 Click **[Login]**.

2 Enter a login user name and password, and then click **[OK]**.

Note

- For user code authentication, enter a user code in **[User Name]**, and then click **[OK]**.
- The procedure may differ depending on the Web browser used.

Log off (using a Web browser)

Click **[Logout]** to log off when user authentication is set.

Note

- It is recommended that you use a Web Image Monitor running under the same network environment as this machine. Otherwise, the Web browser may not open and an error may occur.

2. Faxing





Placing Originals

Place the originals on the exposure glass or the Auto Document Feeder (ADF) in the proper way according to the type of paper shown in the diagram.

For details about original types and how to set original sizes, see *Copy Reference*. You cannot use **[Special Original]** under Copy Function. See "Placing Originals", *Copy Reference*.

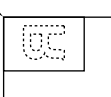

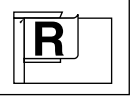

Note that original sizes that can be automatically detected differ slightly to those sizes listed in "Sizes Detectable by Auto Paper Select", *Copy Reference*. See p.213 "Original Sizes Difficult to Detect", *Facsimile Reference <Advanced Features>* .

❖ How to place A4, B4 JIS (Japanese Industrial Standard), A3, 8½"×11", 8½"×14", and 11"×17" size originals

Original	Where original is placed	
	Exposure glass	The ADF
*1 		
*2 		

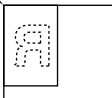
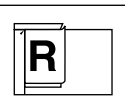
GFSETP01E

❖ How to place A5 and B5 JIS size originals

Original	Where original is placed	
	Exposure glass	The ADF
*2 		
*1 		

GFSETP11E

Note

- ❑ When you place originals as shown in the above illustrations, the fax header on received faxes is printed in the following positions.
 - *1 On the top of the fax
 - *2 On the left side of the fax

Reference

p.79 "Initial Settings and Adjustments"

Limitation

- ❑ If you place A5 size originals on the exposure glass, they are not detected. Place A5 size originals into the ADF. See p.213 "Original Sizes Difficult to Detect", *Facsimile Reference <Advanced Features>* .

 **Note**

- ❑ To scan multiple originals using the Auto Document Feeder (ADF), set originals in a stack.
- ❑ When sending a fax, the image output at the other end depends on the size and orientation of paper used in the receiver's machine. If the receiver does not use paper of the same size and orientation as that of the original, the fax image may be reduced in size, trimmed at both edges, or divided across two or more sheets. When sending an important original, ask the receiver about the size and orientation of the paper in their machine.
- ❑ When sending an original of irregular (i.e. custom) size or part of a large original, you can specify the scan area precisely. See p.13 "Setting a Scan Area".
- ❑ Custom size originals are scanned as regular size originals, so the receiver may find extra blank margins or edges of images missing. If you specify a scan area, only that area is scanned regardless of the actual size of the original.
- ❑ To send an original longer than 420 mm (17"), make either of the following settings, and then scan the original using the ADF (if a jam occurs, the original might become damaged because scanning does not stop in this mode):
 - Specify the area under "Scan Area". See p.13 "Setting a Scan Area".
 - Select Long Document mode with the User Parameters. See p.167 "User Parameters", *Facsimile Reference <Advanced Features>* (switch 14, bit 1).
- ❑ Documents longer than 800 mm (32") must be sent by memory transmission (immediate transmission may not be possible).
 - ❑ If an original jams, press the **[Clear/Stop]** key, and then carefully remove the original.
 - ❑ Make sure that all ink, correcting fluid etc., has completely dried before placing your original. If it is still wet, the exposure glass will become marked and those marks will appear on the received image.
 - ❑ If you place an A4 or LT (8¹/₂"×11") size original in the portrait orientation, the machine rotates the image by 90 degrees before sending. See p.79 "Transmission with Image Rotation", *Facsimile Reference <Advanced Features>* .
 - ❑ You can send the first page from the exposure glass then the remaining pages from the ADF. You cannot change from the ADF to the exposure glass. When transmitting from memory, see p.19 "Sending multiple originals using the exposure glass". When sending immediately, see p.25 "Sending multiple originals using the exposure glass".
 - ❑ When using the Internet Fax function, originals are sent at A4 width. Originals larger than A4 are reduced to A4 width. If the receiver's machine is compliant with the T.37 full mode, originals are sent at the width specified in the Address Book. See p.57 "T.37 Full Mode".
 - ❑ When setting bound originals (books, magazines, etc.), you can select to have either the left or right page sent first with the User Parameters. See p.62 "Book Fax", *Facsimile Reference <Advanced Features>* . See p.167 "User Parameters", *Facsimile Reference <Advanced Features>* (switch 06, bit 6).

Reference

For how to place two-sided originals, see p.63 “Two-Sided Transmission (Double-Sided Transmission)”, *Facsimile Reference <Advanced Features>* .

For acceptable types of originals, see p.210 “Acceptable Types of Originals”, *Facsimile Reference <Advanced Features>* .

Setting a Scan Area

Normally, a placed original is scanned according to the automatically detected size. If a scan area is specified, the original is scanned accordingly. Thus, originals can be sent without extra space or blank margins. See p.213 “Original Sizes Difficult to Detect”, *Facsimile Reference <Advanced Features>* .

❖ Auto Detect







Detects the size of the first page and scans all pages using that size. If you want to scan originals of different sizes, use the Mixed Original Sizes function.

Note

- If the machine cannot detect the original size, a confirmation message appears. Place the original again.

❖ Regular

The placed original is scanned according to specified size regardless of actual size.

The sizes that can be specified are A4 , B4 JIS , A3 , 8¹/₂"×11" , 8¹/₂"×14" , and 11"×17" .

❖ Area

Enter the area to be scanned. Only the area in the specified size is scanned regardless of the actual size of a placed original. See p.160 “Programming, Changing and Deleting a Scan Size”, *Facsimile Reference <Advanced Features>* .

❖ Mixed Original Sizes

Select this to individually scan the size of originals loaded into the ADF. For example, when A4 and B4 JIS size originals are sent together, usually all are sent using the size of the first original. By selecting Mixed Original Sizes, the machine scans and sends each original according to its size.

Note

- To cancel the selected scan area, select **[Auto Detect]**. See p.15 “Specifying Auto Detect”.
- When using Mixed Original Sizes, the machine sends the originals by memory transmission.
- When using Mixed Original Sizes, rotation transmission is disabled. See p.79 “Transmission with Image Rotation”, *Facsimile Reference <Advanced Features>* .

Place the originals, and then select any scan settings you require.

Note

- When placing different size originals into the ADF, adjust the document guide to the largest original.
- Small-size originals may be sent at a slight slant since they do not match the document guide.

2 Press [Scan Area].

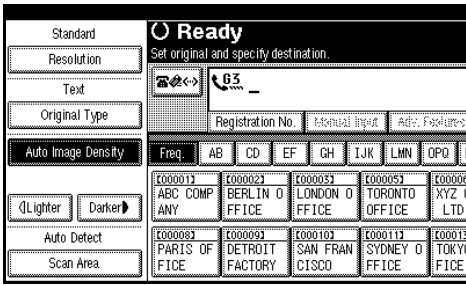

2

3 Select the scan area.

Specifying standard sizes

1 Press [Regular].

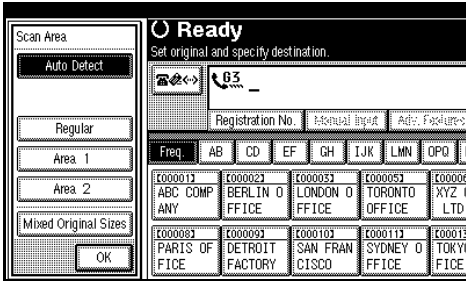

2 Press the size of the originals to be sent, and then press [OK].

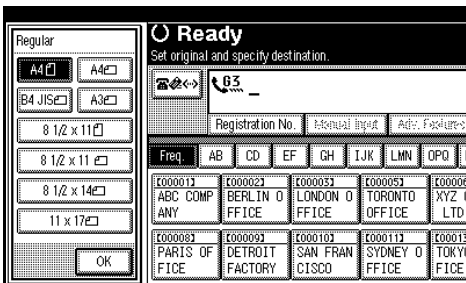

Note

- 8 1/2" x 11" indicates LT. 8 1/2" x 14" indicates LG. 11" x 17" indicates DLT.

3 Press [OK].

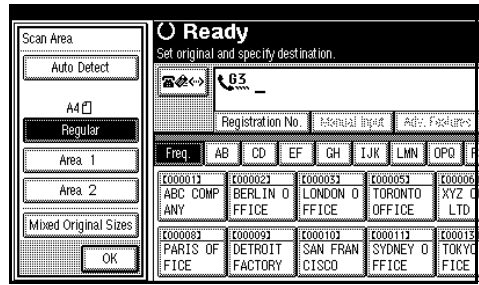

The selected size is shown above the highlighted [Scan Area].

Specifying programmed sizes

1 Press [Area 1] or [Area 2].

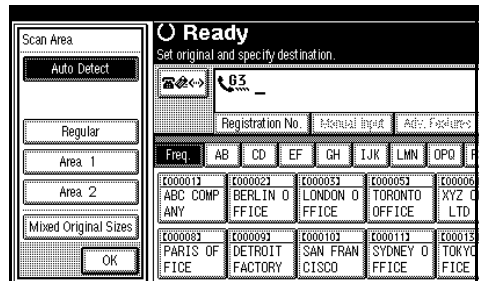

2 Press [OK].

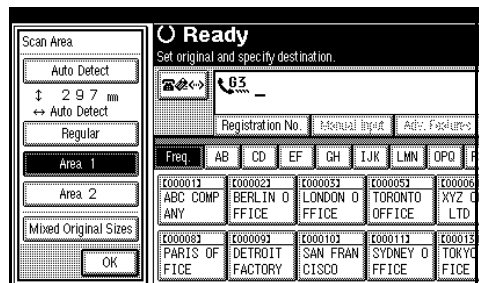

"Area 1" or "Area 2" is shown above the highlighted [Scan Area].

Specifying Mixed Original Sizes

- 1 Press **[Mixed Original Sizes]**.

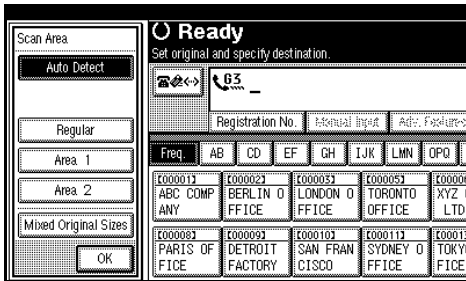

- 2 Press **[OK]**.

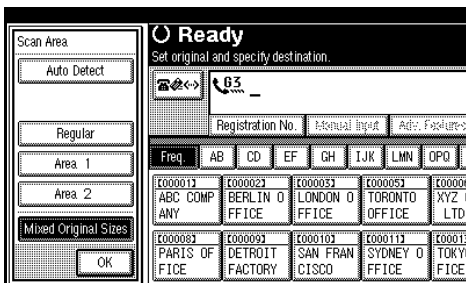

“Mixed Original Sizes” is shown above the highlighted **[Scan Area]**.

Specifying Auto Detect

- 1 Make sure that **[Auto Detect]** is selected.

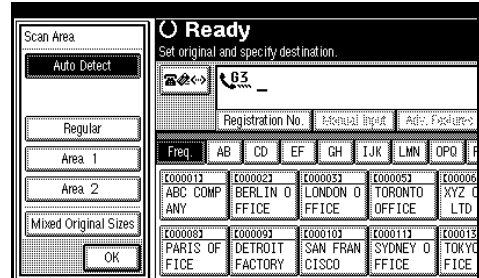

If it is not, press **[Auto Detect]**.

- 2 Press **[OK]**.

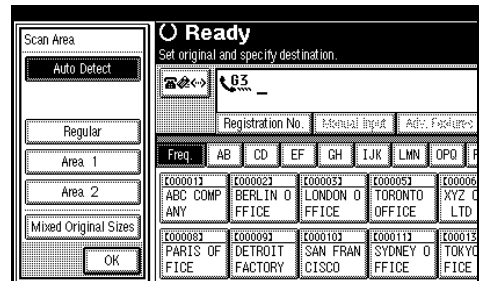

“Auto Detect” is shown above **[Scan Area]**.

- 4 Specify a destination and press the **[Start]** key.

2

Transmission Modes

There are two types of transmission:

- Memory Transmission
- Immediate Transmission

2

❖ Memory Transmission

Transmission starts automatically after the original is stored in memory. This is convenient when you are in a hurry and want to take the document away with you. You can also send the same original to several destinations. See p.20 “Broadcasting sequence”.

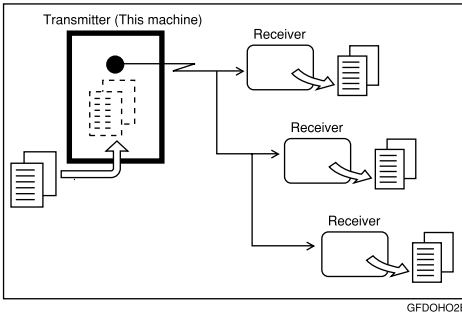

❖ Immediate Transmission

Immediately dials the destination number, and while scanning the original, sends it. It is very convenient when you want to send an original quickly or when you want to check the destination you are sending to. When using this type of transmission, the original is not stored in memory. You can only specify one address.

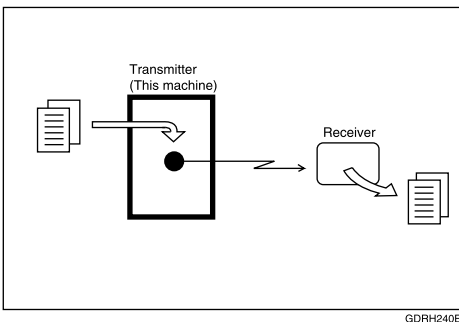

Switching between Memory Transmission and Immediate Transmission

Check the display to see which mode is currently active. You can change transmission mode by pressing **[Immed. TX]** or **[Memory TX]**.

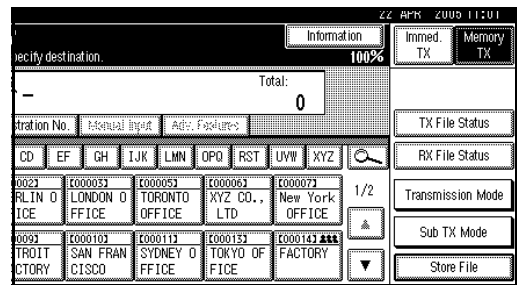

Note

- ❑ You can set the machine to enter Memory Transmission mode or Immediate Transmission mode after the power is turned on or the **[Clear Modes]** key is pressed. See p.145 “General Settings/Adjustment”, *Facsimile Reference <Advanced Features>* .

Memory Transmission

Memory transmission mode has standard fax, Internet Fax and IP-Fax.

Important

- ❑ If there is a power failure (the main power switch is turned off) or the machine is unplugged for about one hour, all the documents stored in memory are deleted. As soon as the main power switch is turned on, the Power Failure Report is printed to help you identify deleted files. Simply turning off the power by pressing the Operation switch does not delete stored documents. See p.202 “Turning Off the Main Power / In the Event of Power Failure”, *Facsimile Reference <Advanced Features>*.
- ❑ It is recommended that you call the receiver and confirm with them when sending important documents.

Limitation

- ❑ If memory is full (0% appears under **[Information]** on the display), Memory Transmission is disabled. Use Immediate Transmission instead.

Note

- ❑ Maximum number of destinations per Memory Transmission: 500.
- ❑ Combined total number of destinations of standby documents stored in memory: 500.
- ❑ After the total number of programmed destination numbers exceeds 500, you can perform only Immediate Transmission.
- ❑ Maximum number of documents that can be stored for Memory Transmission: 400.

- ❑ The number of pages you can store in memory depends on the original images and the scan settings. You can store up to 320 standard pages (ITU-T #1 chart, Resolution: Standard, Original Type: Text). You can store up to 2,240 standard pages, with the optional expansion memory installed.
- ❑ For details about how to confirm the transmission result, see p.27 “Confirming Transmission”.
- ❑ A fax number, e-mail address and IP-Fax number can be specified simultaneously.

Reference

p.59 “Sending Internet Fax Documents”

p.76 “Sending by IP-Fax”

- 1** Make sure that **[Memory TX]** is selected.

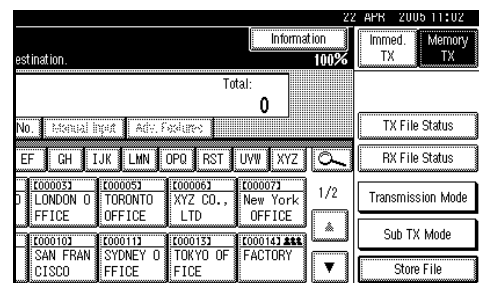

- 2** Place the original.

Note

- ❑ The original can be placed either into the ADF or on the exposure glass, until the **[Start]** key is pressed.

Reference

p.11 “Placing Originals”

3 Make the scan settings you require.

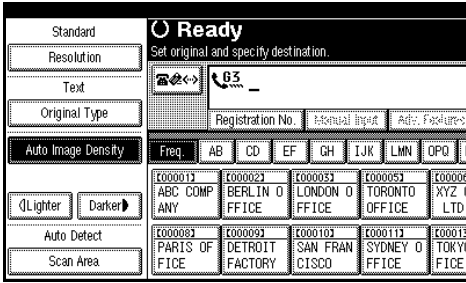

Reference

- p.30 "Scan Settings"
- p.31 "Original Type"
- p.32 "Image Density (Contrast)"

4 Specify a destination.

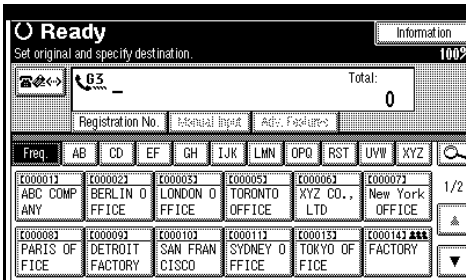

If you do not want to do a broadcast transmission, proceed to step **7**.

Note

- If you make a mistake, press the **[Clear/Stop]** key, and then enter the correct number.

Reference

- p.35 "Entering a Fax Number"
- p.37 "Entering an E-mail Address"
- p.38 "Entering an IP-Fax Destination"
- p.41 "Using the Destination List to Specify Single or Group Destinations"
- p.47 "Chain Dial", *Facsimile Reference <Advanced Features>*
- p.47 "Redial", *Facsimile Reference <Advanced Features>*

5 When sending the same original to several destinations (broadcasting), press **[Add]** to specify the destinations.

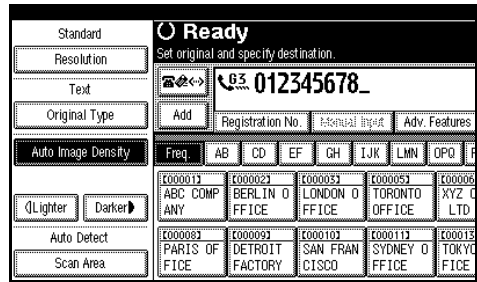

Note

- You do not have to press **[Add]** when adding a destination using the destination list.
- To be extra sure a destination is added, in User Parameters you can set the machine so that **[Add]** must be pressed each time a destination is added. See p.167 "User Parameters", *Facsimile Reference <Advanced Features>* (switch 17, bit 2).

6 Specify a destination.

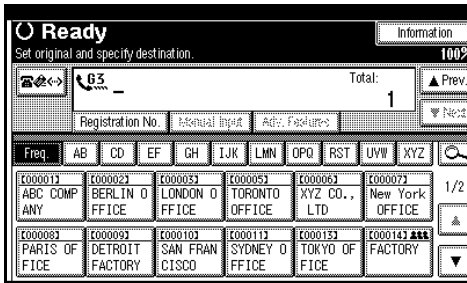

Note

- Pressing switches the destination list between fax number, e-mail address, and IP-Fax number.
- To specify another destination, repeat steps 5 and 6.

7 Press the [Start] key.

Note

- Do not lift the ADF while using it to scan originals.

The machine dials the destination. After scanning, the standby display appears.

Sending multiple originals using the exposure glass

- ① Make sure that [Memory TX] is selected.
- ② Place the first page of the original face down on the exposure glass.
- ③ Specify a destination.
- ④ Make the scan settings you require.
- ⑤ Press the [Start] key. The machine starts scanning.
- ⑥ Place the next original on the exposure glass within 60 seconds after the machine has finished scanning the first original.

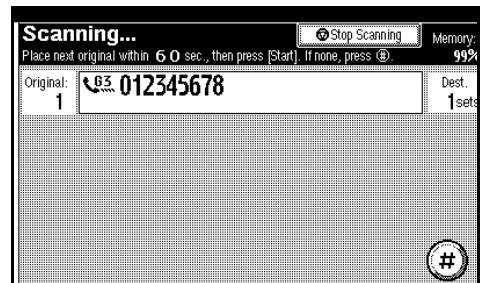

- ⑦ Repeat steps ④ to ⑥ for all originals.
- ⑧ Place the last original, and then press [#]. The machine dials the destination and starts transmission.

💡 Checking the transmission settings

You can check the transmission settings (e.g. destination and transmission mode) on the display.

- ① Press the **[Check Modes]** key, and then check the transmission settings.

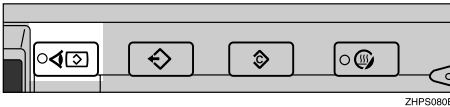

The following display appears.

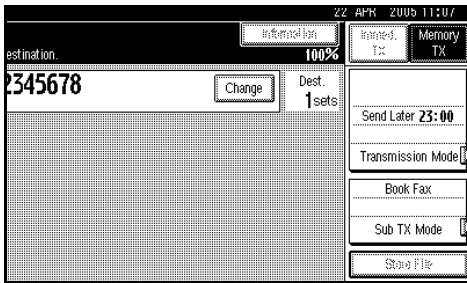

📝 Note

- Pressing **[Check Modes]** switches the destination list between fax number, e-mail address, and IP-Fax number.
- ② After checking the settings on the display, press the **[Check Modes]** key. The display before the **[Check Modes]** key was pressed appears.

💡 Broadcasting sequence

If you dial several destinations for the same document (broadcasting), the documents are sent in the order in which they were dialed. If the fax document could not be transmitted, the machine redials that destination after the last destination specified for broadcasting. For example, if you specify four destinations, A through D, for broadcasting, and if the lines to destinations A and C are busy, the machine dials the destinations in the following order: A, B, C, D, A, and C. See p.80 "Simultaneous Broadcast", *Facsimile Reference <Advanced Features>* .

To check the transmission progress, print the TX file list. See p.26 "Printing a List of Files in Memory (Print TX File List)", *Facsimile Reference <Advanced Features>* .

If the optional extra G3 interface unit is installed, you can use the Simultaneous Broadcast function to send faxes simultaneously on different phone lines.

💡 Memory Transmission sequence

If you specify a second transmission while broadcasting to several destinations, faxes are transmitted alternately to each remaining destination in the current and second broadcast.

For example, if you specify a broadcast to destinations A and B, and then specify a broadcast to destinations C and D while transmission to destination A is in progress, the machine sends the faxes in the following order: A, C, B, and then D.

If the previous file and next file are both on standby, these are also sent in the same order.

Canceling a Memory Transmission

You can cancel the mode using the same procedure in the following cases:

- Fax Destination, Internet Fax Destination, and IP-Fax Destination are specified simultaneously.
- Only either Internet Fax Destination or IP-Fax Destination is specified.

Before the Original Is Scanned

Use this procedure to cancel a transmission before pressing the **[Start]** key.

- 1 Press the **[Clear Modes]** key.

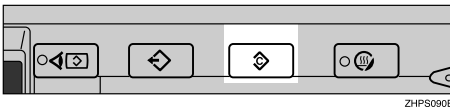

Note

- When originals are placed into the ADF, you can cancel transmission simply by removing them.

While the Original Is Being Scanned

Use this procedure to cancel a transmission after pressing the **[Start]** key.

- 1 Press the **[Clear/Stop]** key.

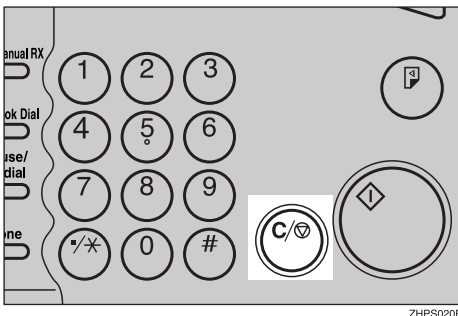

The machine stops scanning.

Note

- You can also cancel scanning by pressing **[Stop Scanning]**.
- Scanning may be completed while you are performing the cancel operation.

While the Original Is Being Transmitted

Note

- If the transmission finishes while you are carrying out this procedure, it will not be canceled.
- If you cancel a document while it is being sent, the transmission is halted as soon as you finish the cancellation procedure. However, some pages of the document may already have been sent and received at the other end.

- 1 Press the **[Clear/Stop]** key.

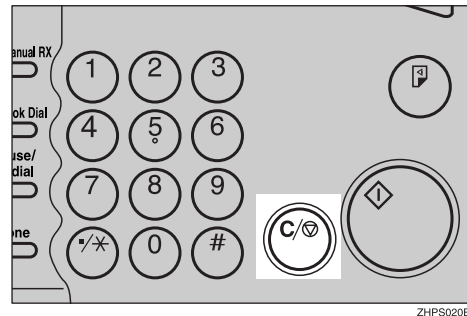

Note

- You can also cancel a Memory Transmission by pressing **[Change / Stop TX File]**.

2 Select the file you want to cancel.

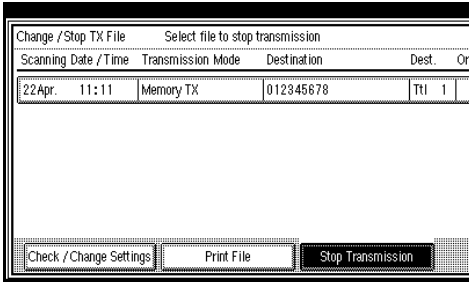

Note

- If the desired file is not shown, press [**▲Prev.**] or [**▼Next**] to find it.
- There are cases when a destination may not be selected as the destination appears as “*”, depending on the security settings.

3 Press [**Stop Transmission**].

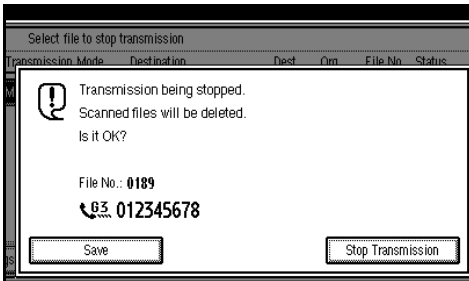

Note

- To cancel another file, repeat steps **2** and **3**.
- To cancel stopping transmission, press [**Save**].

4 Press [**Exit**].

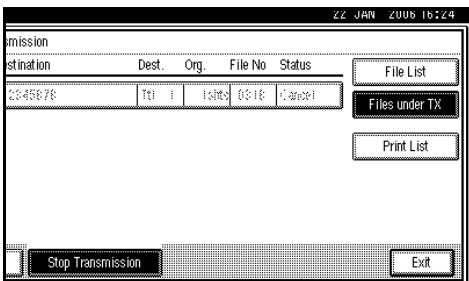

The standby display appears.

Before the Transmission Is Started

Use this procedure to cancel a transmission after the original is scanned. To cancel transmission to some destinations that a fax is sent to, see p.20 “Deleting a Destination”, *Facsimile Reference <Advanced Features>*.

1 Press [**Change / Stop TX File**].

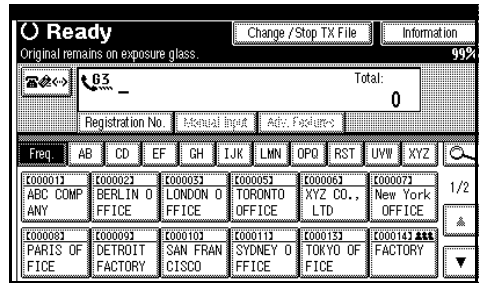

The list of stored files being transmitted or waiting for transmission appears.

2 Select the file you want to cancel.

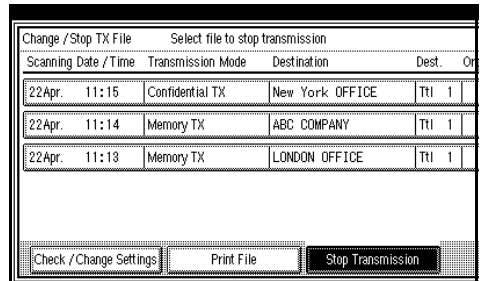

Note

- If the desired file is not shown, press [**▲Prev.**] or [**▼Next**] to find it.
- There are cases when a destination may not be selected as the destination appears as “*”, depending on the security settings.

3 Press [Stop Transmission].

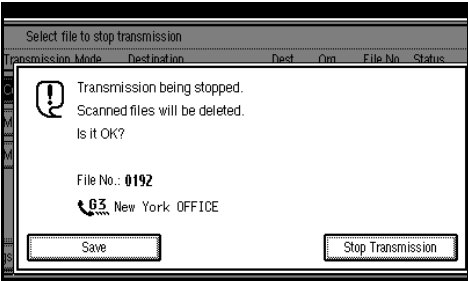

2

Note

- To cancel another file, repeat steps **2** and **3**.
- To cancel stopping transmission, press [Save].

4 Press [Exit].

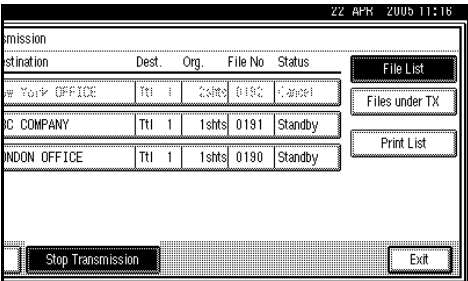

The standby display appears.

Immediate Transmission

Limitation

- Internet Fax is executed in only Memory Transmission that starts transmission automatically after storing documents in memory. If you specify Immediate Transmission in Internet Fax, the mode is switched to Memory Transmission while an e-mail address is being entered.

Note

- Documents are not stored in memory.
- You cannot send the same document to multiple destinations (broadcasting). Memory Transmission allows this function.
- For details about how to confirm the transmission result, see p.27 "Confirming Transmission".

1 Make sure that [Immed. TX] is selected.

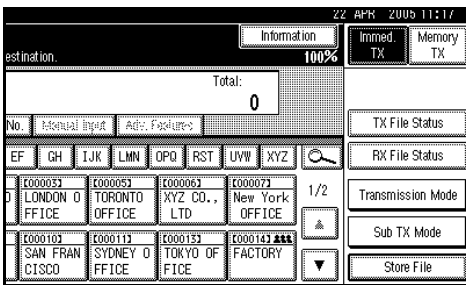

2 Place the original.

Note

- The original can be placed anytime before the **[Start]** key is pressed.

Reference

p.11 "Placing Originals"

3 Select the scan settings you require.



Reference

p.30 "Scan Settings"

4 Specify a destination.

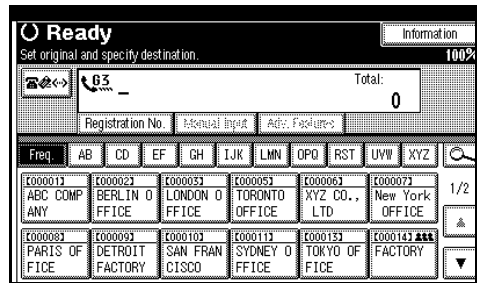

Limitation

- Group cannot be used for Immediate Transmission. The machine automatically changes to Memory Transmission.

Note

- If you make a mistake, press the **[Clear/Stop]** key, and then enter the correct number.

Reference

p.35 "Entering a Fax Number"
 p.38 "Entering an IP-Fax Destination"
 p.35 "Specifying a Destination"
 p.47 "Chain Dial", *Facsimile Reference* <Advanced Features>
 p.47 "Redial", *Facsimile Reference* <Advanced Features>

5 Press the **[Start]** key.

The machine dials a destination.

Note

- Do not lift the ADF while using it to scan originals.

After transmission, the standby display appears.

2

Sending multiple originals using the exposure glass

- ① Make sure that **[Immed. TX]** is selected.
- ② Place the first page face down on the exposure glass.
- ③ Specify a destination.
- ④ Make the scan settings you require.
- ⑤ Press the **[Start]** key.
- ⑥ Place the next original on the exposure glass within 10 seconds after the machine has finished scanning the first original.

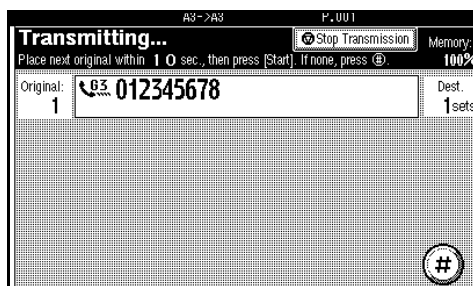

- ⑦ Repeat steps ④ to ⑥ for all originals.
- ⑧ Place the last original, and then press **[#]**.

Canceling an Immediate Transmission

2

Before You Have Pressed the [Start] Key

Use this procedure to cancel a transmission before pressing the [Start] key.

1 Press the [Clear Modes] key.

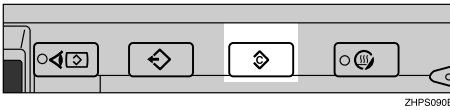

Note

- When the original is placed into the ADF, you can also cancel an Immediate Transmission by removing the original.

Note

- You can also cancel an Immediate Transmission by pressing [Stop Transmission].
- If the transmission finishes while you are carrying out this procedure, it is not canceled.

After You Have Pressed the [Start] Key

Use this procedure to cancel a transmission after pressing the [Start] key.

1 Press the [Clear/Stop] key, and then remove the original.

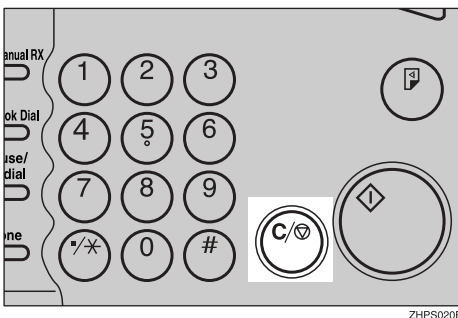

Confirming Transmission

You can confirm transmission by the display, report, or e-mail.

Confirming on Display

Use the TX File Status. See p.31 “Checking the Transmission Result (TX File Status)”, *Facsimile Reference <Advanced Features>* .

Confirming by Report

Print reports for confirmation.

Memory Transmission

If a document cannot be sent, a Communication Failure Report is automatically printed. Or, you can use the Communication Result Report to check each transmission result regardless of status.

This report is printed each time a Memory Transmission is completed if turned on with User Parameters. See p.167 “User Parameters”, *Facsimile Reference <Advanced Features>* (switch 03, bit 0).

You can also print the report by programming the TX Status Report to a Quick Operation key and pressing this when specifying a destination. See p.145 “General Settings/Adjustment”, *Facsimile Reference <Advanced Features>* .

If you turn the Communication Result Report on, the Communication Failure Report is not printed. See p.82 “Communication Failure Report”, *Facsimile Reference <Advanced Features>* . See p.28 “Communication Result Report (Memory Transmission)”.

Immediate Transmission

You can confirm the result with an Immediate TX Result Report.

Select to print this report in User Parameters. A report is printed after every Immediate Transmission is completed. See p.167 “User Parameters”, *Facsimile Reference <Advanced Features>* (switch 03, bit 5).

You can also print the report by programming the TX Status Report to a Quick Operation key and pressing this when specifying a destination. See p.145 “General Settings/Adjustment”, *Facsimile Reference <Advanced Features>* .

See p.29 “Immediate TX Result Report (Immediate Transmission)”.

Confirming by E-mail

Use the E-mail TX Results function to send reports as a Journal by e-mail to your computer. The available reports are:

- Communication Result Report.
- Immediate TX Result Report.
- Polling TX Clear Report.
- Polling RX Result Report.

By programming the E-mail TX Results to a Quick Operation key in advance, you can send transmission results by e-mail after each transmission is completed. You can also use the Sender Settings function to send the transmission results to senders’ e-mail addresses that have been programmed.

If you send fax documents from a computer, use LAN-Fax Driver to specify whether or not the LAN-Fax Result Report is sent to the computer.

Preparation

You must first register the e-mail addresses of the destinations the report is to be sent to on the destination list. See “Fax Destination”, *General Settings Guide*.

Note

- When using E-mail TX Results pre-programmed to a Quick Operation key, select the destination for notification from the Internet Fax destinations in the destination list.
- When using Sender Settings pre-programmed to a Quick Operation key, select the sender from the Internet Fax destinations in the destination list.

Reference

p.5 “Sender Settings”, *Facsimile Reference <Advanced Features>*

p.13 “Polling Transmission Clear Report”, *Facsimile Reference <Advanced Features>*

p.16 “Polling Reception Result Report”, *Facsimile Reference <Advanced Features>*

p.117 “Confirming transmission results by e-mail”, *Facsimile Reference <Advanced Features>*

p.145 “General Settings/Adjustment”, *Facsimile Reference <Advanced Features>*

Confirming by Report and E-mail

You can confirm transmission results using both the E-mail TX Results function, which sends the results by e-mail, and the Communication Result Report printed by the machine.

You can set whether to use both of these together in User Parameters. See p.167 “User Parameters”, *Facsimile Reference <Advanced Features>* (switch 10, bit 6).

Communication Result Report (Memory Transmission)

This report is printed when a Memory Transmission is completed, so you can check the result of the transmission. If E-mail TX Results is programmed in a Quick Operation key, you can select whether a report e-mail is sent after transmission. See p.145 “General Settings/Adjustment”, *Facsimile Reference <Advanced Features>*.

Note

- If two or more destinations are specified, this report is printed after the fax document is sent to all the destinations.
- If the machine is set up not to print this report and the fax document could not be successfully transmitted, a Communication Failure Report is printed. See p.82 “Communication Failure Report”, *Facsimile Reference <Advanced Features>*.
- You can turn this function on or off with the User Parameters. See p.167 “User Parameters”, *Facsimile Reference <Advanced Features>* (switch 03, bit 0).

- ❑ You can select whether to include part of the original image on the report. See p.167 “User Parameters”, *Facsimile Reference <Advanced Features>* (switch 04, bit 7).
- ❑ To view the report without text disruption, select a font of even character width in your e-mail application's settings.
- ❑ You can display a destination with the User Parameters. See p.167 “User Parameters”, *Facsimile Reference <Advanced Features>* (switch 04, bit 4).
- ❑ You can display a sender name with the User Parameters. See p.167 “User Parameters”, *Facsimile Reference <Advanced Features>* (switch 04, bit 5).
- ❑ The Page column gives the total number of pages. The Not Sent column gives the number of pages that could not be sent successfully.
- ❑ “--” indicates that the Internet Fax document was sent to the mail server programmed in this machine. (However, this does not mean the e-mail was delivered.)

Immediate TX Result Report (Immediate Transmission)

If you turn this report on, a report is printed after every Immediate Transmission so you have a record of whether the transmission was successful or not. If the machine is set up not to print this report and the fax document could not be successfully transmitted, the Error Report is printed instead. If E-mail TX Results is programmed in a Quick Operation key, you can select whether a report e-mail is sent after transmission. See p.145 “General Settings/Adjustment”, *Facsimile Reference <Advanced Features>* .

Note

- ❑ You can switch this report on or off in the User Parameters. See p.167 “User Parameters”, *Facsimile Reference <Advanced Features>* (switch 03, bit 5).
- ❑ To view the report without text disruption, select a font of even character width in your e-mail application's settings.
- ❑ You can display a destination with the User Parameters. See p.167 “User Parameters”, *Facsimile Reference <Advanced Features>* (switch 04, bit 4).
- ❑ If the page was sent successfully, the Page column gives the total number of pages sent successfully.

Scan Settings

You may want to send many different types of fax documents. Some of these may be difficult to reproduce at the receiver's end. However, the machine has three settings that you can adjust to help you transmit the document with the best possible image quality.

- ❖ **Resolution:**
Standard, Detail, Super Fine (optional)
- ❖ **Original Type:**
Text, Text / Photo, Photo
- ❖ **Image Density (Contrast):**
Auto Image Density, Manual Image Density (seven levels), Combined Auto and Manual Image Density

Resolution

Images and text are scanned into the machine by converting them to a sequence of dots. The density of the dots determines the quality of the image and how long it takes to transmit. Therefore, images scanned at high resolution (Super Fine) have high quality but transmission takes longer. Conversely, low resolution (Standard) scanning results in lower quality but the original is sent more quickly. Select the setting that matches your needs based upon this trade off between speed and image clarity.

- ❖ **Standard (8 x 3.85 lines/mm, 200 x 100 dpi)**
Select for originals containing normal size characters.

- ❖ **Detail (8 x 7.7 lines/mm, 200 x 200 dpi)**
Select for originals containing small characters or when you require greater clarity. This resolution is twice as fine as Standard.

- ❖ **Super Fine (optional expansion memory required: 16 x 15.4 lines/mm, 400 x 400 dpi)**
Select for originals with very fine details or when you require the best possible image clarity. This resolution is eight times finer than Standard.

⚠ Limitation

- If the other party's machine does not support the resolution at which you are sending, this machine automatically switches to a resolution that is supported. You can check the resolution at which you actually sent. See p.162 "Printing Journal", *Facsimile Reference <Advanced Features>* .
- Sending with Super Fine resolution requires that the machine has the optional expansion memory, and the other party's machine has the capability to receive fax documents at Super Fine resolution.

📝 Note

- The machine supports Standard, Detail, and (with the optional expansion memory) Super Fine resolutions.
- You can select the resolution type that is selected right after the machine is turned on or modes are cleared with **[Scan End Reset]** under Gen. Settings/ Adjust. See p.145 "General Settings/Adjustment", *Facsimile Reference <Advanced Features>* .

- When using Internet Fax transmission, documents are sent at “Detail” resolution, even if you have specified “Super Fine”. To send a document at “Super Fine”, configure the Full Mode when registering the destinations in the Address Book. See p.57 “T.37 Full Mode”.

1 Press [Resolution].

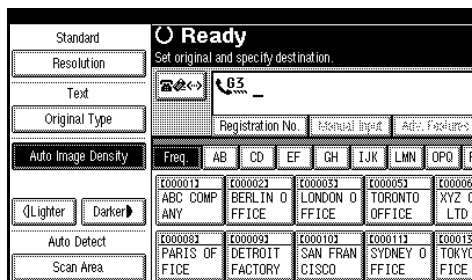

2 Select the resolution you require, and then press [OK].

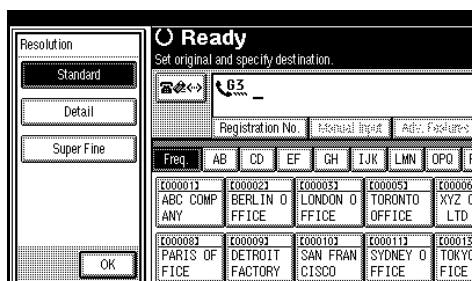

Note

- If you install the optional expansion memory, “Super Fine” appears in the Resolution box.

Original Type

If the original contains photographs, illustrations, or diagrams with complex shading patterns or grays, select the appropriate original type to optimize image clarity.

❖ Text

Select **[Text]** to send high-contrast black-and-white image originals. Use this setting when you only want to send clearer text, even if the original contains text and photographs.

❖ Text / Photo

Select **[Text / Photo]** to send an original containing both a high-contrast black-and-white image, such as text, and a halftone image, such as a photograph.

❖ Photo

Select **[Photo]** to send an original containing a halftone image, such as a photograph or a colour original.

Note

- If you select **[Text / Photo]** or **[Photo]**, the transmission will take longer than when **[Text]** is selected.
- If you send a fax document with **[Text / Photo]** or **[Photo]** and the background of the received image is dirty, reduce the density setting and resend the fax. See p.32 “Image Density (Contrast)”.
- You can set the original type that is selected right after the machine is turned on or the **[Clear Modes]** key is pressed, with **[Original Type Priority]** under Gen. Settings/Adjust. See p.145 “General Settings/Adjustment”, *Facsimile Reference <Advanced Features>*.

1 Press [Original Type].

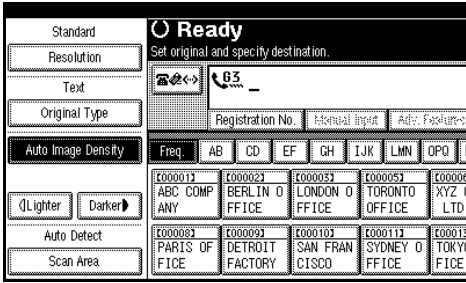

2 Select the original type you require, and then press [OK].

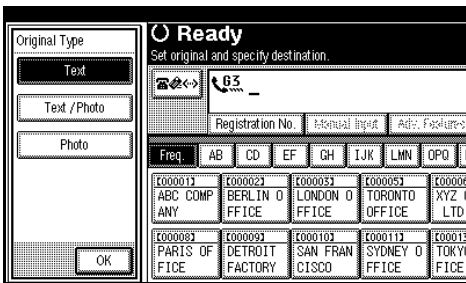

Image Density (Contrast)

The text and diagrams on originals should stand out clearly from the paper they are on. If the original has a darker background than normal (for example, a newspaper clipping), or if the writing is faint, adjust the image density.

❖ **Auto Image Density**

The appropriate density setting for the original is automatically selected.

❖ **Manual Image Density**

Use manual image density to set image density manually. You can select one of seven image density levels.

❖ **Combined Auto and Manual Image Density**

You can only adjust image density for photographs, illustrations, or diagrams if the original has a dark background.

You can select one of seven image density levels.

Note

- ❑ Selecting [Text] or [Text / Photo] for the original type causes [Auto Image Density] to be selected.
- ❑ You can set the image density that is selected right after the machine is turned on or the [Clear Modes] key is pressed, with [Auto Image Density] under Gen. Settings/ Adjust. See p.145 "General Settings/ Adjustment", *Facsimile Reference <Advanced Features>*.

1 Select the type of image density.

Auto Image Density

1 Make sure that [Auto Image Density] is selected.

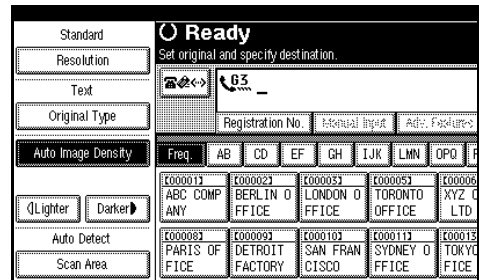

Manual Image Density

- 1 Make sure that [Auto Image Density] is not selected. If it is selected, press [Auto Image Density] to turn it off.
- 2 Press [◀ Lighter] or [Darker ▶] to adjust the density.

The square moves.

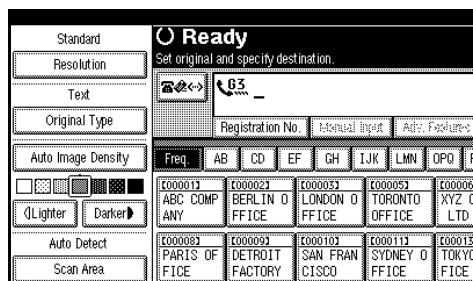

Combined Auto and Manual Image Density

- 1 Select the [Auto Image Density].
- 2 Press [◀ Lighter] or [Darker ▶] to adjust the density.

The square moves.

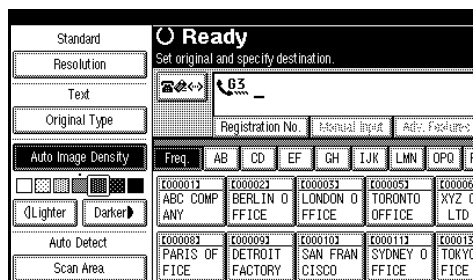

Mixing Scan Settings for a Multiple Page Original

When sending an original of several pages, you can select a different image density, resolution, and original type setting for each page.

Place the original, select the scan settings for the first page, dial, and then press the [Start] key as you would normally. Then follow one of the following two procedures.

Note

- It is recommended that originals be placed on the exposure glass when mixing scan settings for a multiple page original.

When placing originals on the exposure glass

Note

- While the machine is beeping, you have about 60 seconds (10 seconds for Immediate Transmission) to select density, resolution, and original type. The time remaining is shown on the display.

- 1 Check which pages you want to scan with different settings.
- 2 Remove the previous page and place the next page.

- 3** Select the image density, resolution, and original type.



Note

- Adjust the settings for each page before you press the **[Start]** key.

When placing originals in the optional Auto Document Feeder (ADF)

Note

- Depending on what time the scan settings are adjusted, the settings may not be reflected in the resulting operation.

- 1** Check which pages you want to scan with different settings.

- 2** Select the image density, resolution, and original type before the next page is scanned.

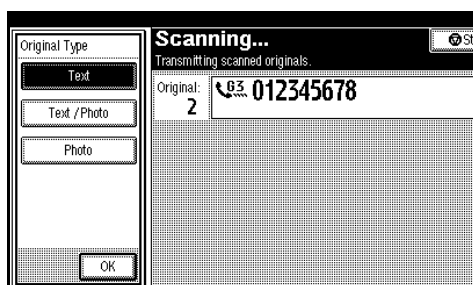

Specifying a Destination

You can specify the destination using one of four methods.

- ❖ **Fax number**
p.35 “Entering a Fax Number”
- ❖ **E-mail address**
p.37 “Entering an E-mail Address”
- ❖ **IP-Fax destination**
p.38 “Entering an IP-Fax Destination”
- ❖ **Destination list**
p.41 “Using the Destination List to Specify Single or Group Destinations”

This section covers these functions and others in more detail.

Note

- The display shows the percentage of free memory space for storing originals. Since fax numbers and e-mail addresses are programmed in separate memory, dialing fax numbers using the number keys does not change the percentage on the display.

Entering a Fax Number

Enter numbers directly using the key pad on the right side of the control panel.

Note

- Maximum length of a fax number: 128 digits.
- You can insert pauses and tones in a fax number. See p.36 “Pause”, p.36 “Tone”.

- 1** Enter the fax number using the number keys.

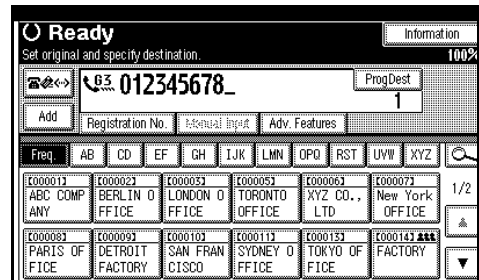

Note

- If you make a mistake, press the **[Clear/Stop]** key, and then enter again.
- If the optional extra G3 interface unit is installed, select G3 before pressing the **[Start]** key. See p.60 “Changing the Line Port”, *Facsimile Reference <Advanced Features>* .
- Press **[ProgDest]** after entering the fax number to store the fax number in the destination list. See p.40 “Registering Entered Destinations to the Address Book”.

Pause

Press the **[Pause/Redial]** key when dialing or storing a number to insert a pause of about two seconds.

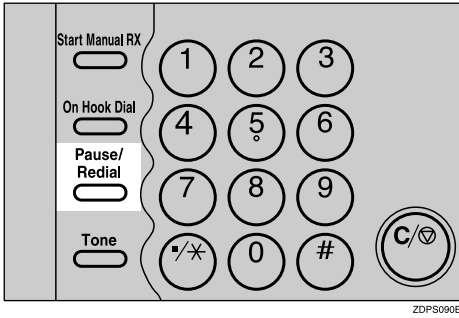

Note

- If you press the **[Pause/Redial]** key at the first digit, the Redial screen appears. See p.47 “Redial”, *Facsimile Reference <Advanced Features>* .
- A pause is shown as a “-” on the display.

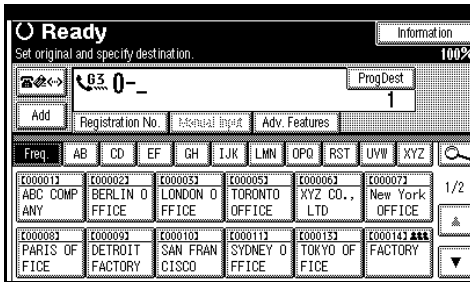

Note

- You can also program numbers including pauses in the destination list.

Tone

This function allows a machine connected to a pulse dialing line to send tonal signals (for example if you want to use a special service on a tone dialing line). When you press the **[Tone]** key, the machine dials the number using tonal signals.

Limitation

- Certain services may be unavailable even when using the **[Tone]** key.

Note

- A tone is shown as a “•” on the display and the next numbers are dialed using tonal signals.

Using the **[Tone]** key with On Hook Dial

1 Press the **[On Hook Dial]** key.

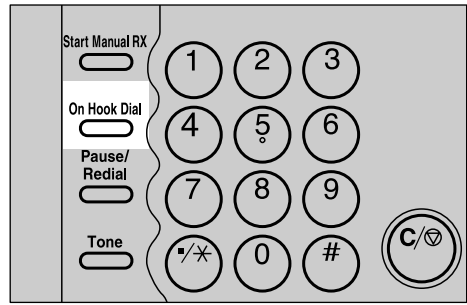

2 Enter the fax number using the number keys.

3 Press the **[Tone]** key.

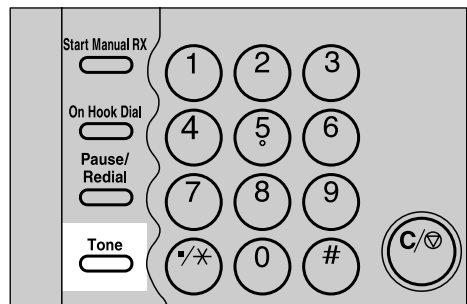

- 4 Enter the number you want to tone dial using the number keys.

Entering an E-mail Address

When using Internet Fax transmission, specify the e-mail address in place of the fax number. See p.55 “Internet Fax Functions (by Specifying an E-mail Address)”.

Note

- You can enter up to 128 characters.

- 1 Press to switch the destination to e-mail address.

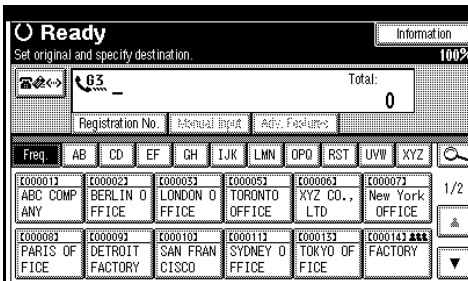

- 2 Press [Manual Input].

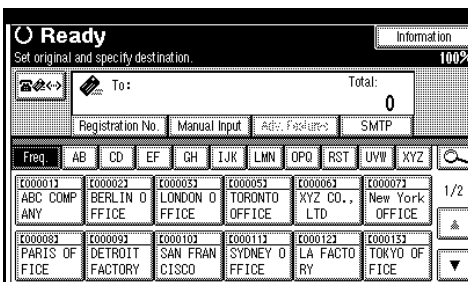

Note

- Depending on security settings, [Manual Input] may not appear, and you may be unable to enter the e-mail address.

- 3 Enter the e-mail address destination and then press [OK].

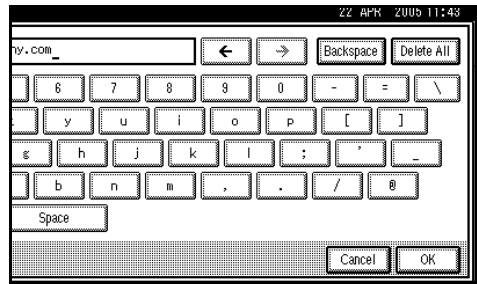

Note

- You can specify whether or not to bypass the SMTP server by pressing [SMTP]. See p.66 “Bypassing the SMTP Server”.
- If you enter an incorrect character, press [Backspace] or [Delete All]. Then, re-enter the characters correctly.
- To change the e-mail address after pressing [OK], press [Edit Dest.], re-enter an e-mail address, and then press [OK].

Reference

“Entering Text”, *General Settings Guide*

The destination is specified.

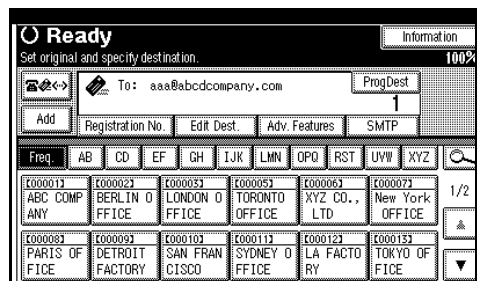

Note

- Press [ProgDest] in this order to store the entered e-mail address in the address book. See p.40 “Registering Entered Destinations to the Address Book”.

When bypassing the SMTP server

To bypass the SMTP server when sending fax documents, specify destinations as follows:

Preparation

Program the host name of the other party on the DNS server in advance. See “Using a Host Name Instead of an IP Address”, *Network Guide*.

Limitation

- If the other party's IP address is not registered on the DNS server, specify the IP address at the domain part of the e-mail address.

❖ Specify the other party's host name

Specify a destination's e-mail address by adding the other party's host name to the domain part of the e-mail address. Specify the address to the right of @ as follows: “host name”, “.” (period), and “domain name”.

xxxx@host name of the other party.domain name

Example: The other party's e-mail address is “abc@defcompany.com” and the host name is “HOST”; abc@HOST.defcompany.com

❖ Specify the other party's IP address

Specify a destination's e-mail address by changing the domain part of the e-mail address to the other party's IP address.

xxxx@[the other party's IP address]
Example: The other party's e-mail address is “abc@defcompany.com” and the IP address is “192.168.1.10”; abc@[192.168.1.10]

Entering an IP-Fax Destination

When using IP-Fax transmission, specify the IP-Fax destination (IP address, host name, or alias telephone number) in place of the fax number. See p.73 “Internet Fax Functions (by Specifying an IP Address)”.

Note

- You can enter up to 128 characters.

1 Press  to switch the destination to IP-Fax destination.

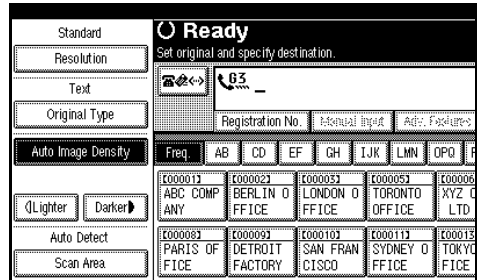

2 Press [Manual Input].

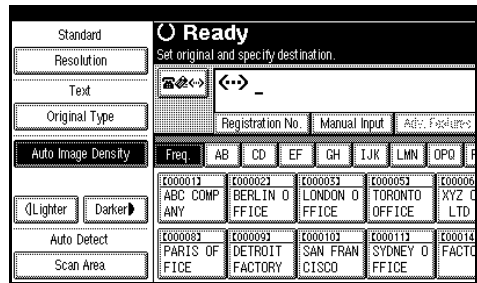

Note

- Depending on security settings, [Manual Input] may not appear, and you may be unable to enter the IP-Fax destination.

3 Enter the IP-Fax destination, and then press [OK].

Note

- If you have set both of “Enable H.323” and “Enable SIP” parameters to “On” with “IP-Fax Settings” under “Facsimile Features”, [Protocol] appears. Press this button to select a protocol to be used.
- If you enter an incorrect character, press [Backspace] or [Delete All]. Then, re-enter the characters correctly.
- To change the IP-Fax destination after pressing [OK], press [Edit Dest.], re-enter an IP-Fax destination, and then press [OK].

Reference

“Entering Text”, *General Settings Guide*

The destination is specified.

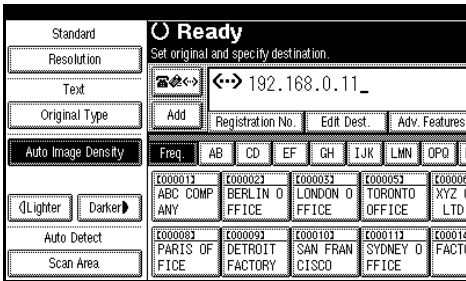

Note

- Press [ProgDest] in this order to store the entered IP-Fax destination in the Address Book. See p.40 “Registering Entered Destinations to the Address Book”.

IP-Fax destination

Depending on the network to which this machine is connected or this machine's configuration, enter the IP-Fax destination as follows:

❖ When not using a gatekeeper/SIP server

- From IP-Fax to IP-Fax
Specify the IP address or host name of the receiving machine.
Example: 192.168.1.10 (IP address)
Example: tokyo.abc.co.jp (host name)
- From IP-Fax to G3 fax
Specify the G3 fax telephone number of the receiving machine.
Example: 0312345678

❖ When using a gatekeeper/SIP server

- From IP-Fax to IP-Fax
Specify the alias telephone number of the receiving machine.
Example: 0311119999 (alias telephone number)
- From IP-Fax to G3 fax
Specify the G3 fax telephone number of the receiving machine.
Example: 0312345678

Note

- ❑ When you enter a destination via a gateway (G3 fax connected to the public telephone line, etc.) into the Address Book or Destination List, you must specify its machine telephone number. To send from an IP-Fax to G3 fax without using gatekeeper or SIP server, you must register the gateway also. See p.150 “IP-Fax Settings”, *Facsimile Reference* <Advanced Features>
- ❑ When you specify a destination with IP-Fax, depending on the receiver’s network configuration, you may need to specify the IP address and port number of the receiving machine. For example, if the receiver’s IP address is “192.168.1.10” and the port number is “2100”, specify “192.168.1.10:2100”. Ask the network administrator for details.
- ❑ When you specify a host name, depending on the receiver’s network configuration, you may need to specify the host name and port number of the receiving machine. For example, if the receiver’s host name is “tokyo.abc.co.jp” and the port number is “2100”, specify “tokyo.abc.co.jp:2100”. Ask the network administrator for details.
- ❑ An alias telephone number is a telephone number available only in the network registered in the gatekeeper.
- ❑ Pay attention to the number of telephone number digits set in the gateway/IP address conversion table to avoid transmission error.



Registering Entered Destinations to the Address Book

You can register a fax number, e-mail address, or IP-Fax destination to the Address Book.

When registering a destination directly entered or displayed on the Redial screen in the Address Book, **[ProgDest]** appears in the destination field.

See “Fax Destination” and “E-mail Destination”, *General Settings Guide*.

Note

- ❑ Depending on security settings, **[ProgDest]** may not appear, and you may be unable to register the destination.
- ❑ When you press the **[Facsimile]** key after changing the contents of the Address Book, the “Destination list / machine settings are updated.” message appears. Press **[Exit]**. The standby display appears.

Reference

“Fax Destination”, *General Settings Guide*

“E-mail Destination”, *General Settings Guide*

“Registering Names to a Group”, *General Settings Guide*

1 Press [ProgDest].

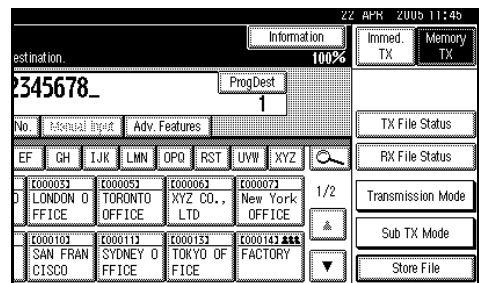

- 2** Press **[Names]** and enter any necessary information.

- 3** Press **[OK]**.

Using the Destination List to Specify Single or Group Destinations

When destinations are programmed in a destination list, you can specify a destination by just selecting a Destination key from the destination list.

The programmed name appears on Destination key.

Pressing switches the destination list between fax number, e-mail address, and IP-Fax number.

If you program multiple destinations into a Group, you can send documents to all destinations in that Group using just a few keystrokes. Destinations programmed in a group are indicated by .

Preparation

In the destination list, program an individual fax number, IP-Fax number, e-mail address and/or groups of destinations. See “Fax Destination”, “E-mail Destination”, and “Registering Names to a Group”, *General Settings Guide*.

Limitation

- Group destination can be used only for Memory Transmission; it cannot be used for Immediate Transmission. The machine automatically changes to Memory Transmission when you use group destination.
- You cannot specify more than 500 destinations for multiple groups.

Note

- To check the contents of Destination keys, print the destination list. See “Administrator Tools”, *General Settings Guide*.
- A stored name can be printed out on the first page of a received fax at the other end. See p.74 “Label Insertion”, *Facsimile Reference <Advanced Features>*.
- To check the contents of the Groups, print the list. See “Administrator Tools”, *General Settings Guide*.

- 1** Press to switch the destination between fax number, e-mail address, and IP-Fax number.

- 2** Press the title word key where the desired destination is programmed.

For example, if you want to specify “NEW YORK OFFICE” programmed in “LMN”, press **[LMN]**.

Freq	AB	CD	EF	GH	IJK	LMN	OPQ	RST	UVW	XYZ
E000012	E000023	E000053	E000053	E000053	E000063	E000072				
ABC COMP	BERLIN O	LONDON O	TORONTO	XYZ CO.,	New York					
ANY	FFICE	FFICE	OFFICE	LTD	OFFICE					
E000083	E000093	E000103	E000113	E000133	E000143					
PARIS OF	DETROIT	SAN FRAN	SYDNEY O	TOKYO OF	FACTORY					
FFICE	FACTORY	CISCO	FFICE	FFICE						

Note

- There are three types of titles for destination lists; “Title 1”, “Title 2”, and “Title 3”. The above display shows “Title 1”.

Switching the titles of destination lists

- 1 Press , the magnifier icon.
- 2 Press [Switch Title].
- 3 Select the type of the title, and then press [Exit].

3 Select a destination.

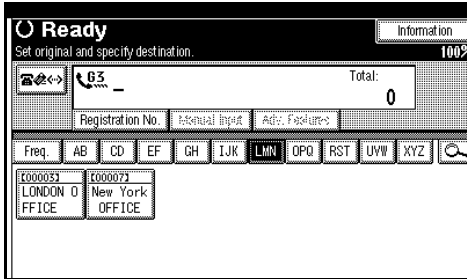

Note

- Pressing  switches the destination list between fax number, e-mail address, and IP-Fax number.

Specifying a single destination

- 1 Press the Destination key programmed with the desired destination.

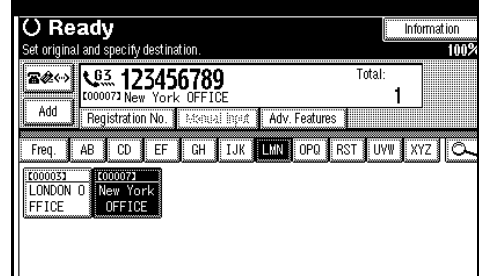

Note

- If the desired Destination key is not shown, press [▲] and [▼] to look through the list.
- To cancel the selection, press the selected Destination key again. You can also press the [Clear / Stop] key to cancel the selection.
- To select more destinations, repeat steps 2 and 3.

Specifying group destinations

- 1 Press the **Destination** key programmed with the desired group.

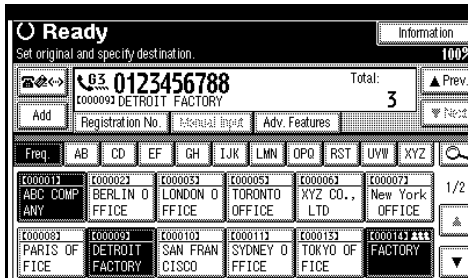

Note

- The destination list registered in the desired group, whose type is selected in step 1, appears.
- To cancel any destination(s) among the group, press [**▲P- rev.**] and [**▼Next**] to display the desired destination. Then, press the [**Clear/Stop**] key. You can also cancel a transmission by pressing the highlighted Destination key to deselect it.

- If a destination where a fax number, e-mail address, or IP-Fax number is not programmed is included in the specified group, the “The specified group contains some invalid destination(s). Do you want to select only valid destination(s)?” message appears. Press [**Select**] to specify destinations where the fax number, the e-mail address, or IP-Fax is programmed. Press [**Cancel**] to change the destination. If the destination in destination type does not exist, you can prioritize a destination you want to quote. See p.167 “User Parameters”, *Facsimile Reference <Advanced Features>* (switch 32, bit 0).
 - To select more groups, repeat steps 2 and 3.
- 4 Press the [**Start**] key.

2

Searching for a Destination

Use this procedure to search through the destination lists for a particular destination.

2

- ❖ **Search by Destination Name**
p.44 "Search by Destination Name"
- ❖ **Search by Fax Number**
p.45 "Search by Fax Number"
- ❖ **Search by E-mail Address**
p.46 "Search by E-mail Address"
- ❖ **Search by IP-Fax Destination**
p.47 "Search by IP-Fax Destination"
- ❖ **Search by LDAP Server**
p.48 "Search by LDAP Server"
- ❖ **Specifying a Registration Number**
p.50 "Specifying a Registration Number"

 **Note**

- ❑ If you press **[Fax]**, **[E-mail]** or **[IP-Fax]** on the search result display, you can switch between fax destination, e-mail destination and IP-Fax destination.
- ❑ The search returns only destinations whose beginnings match the entered name.
- ❑ A warning appears if the search returns more than 100 items. Press **[OK]** and change the destination name to view fewer destinations.

Search by Destination Name

1 Press , the magnifier icon.

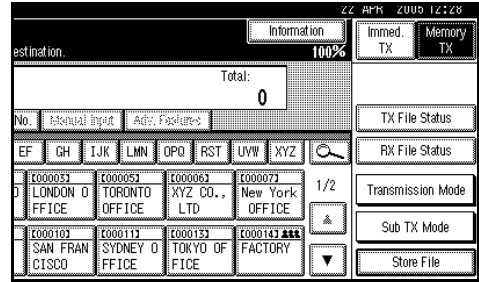

2 Press **[Advanced Search]**.

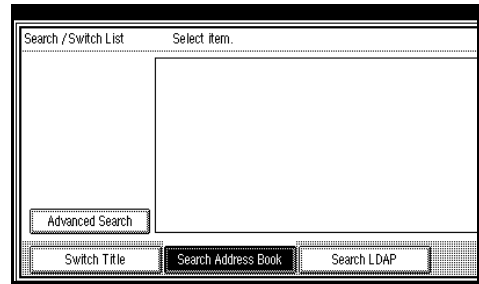

3 Press **[Search by Dest. Name]**.

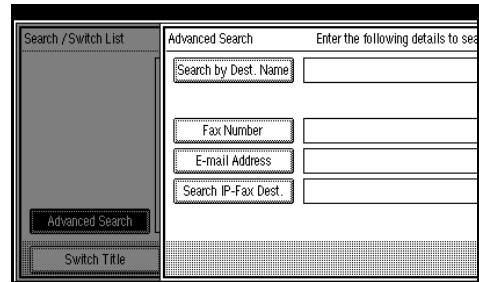

4 Enter a destination name to search for, and then press **[OK]**.

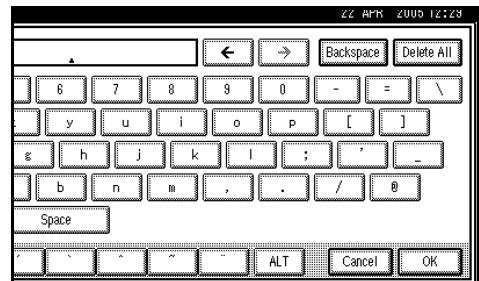

Note

- ❑ If you enter a wrong destination name, press [←] or [→] and [Backspace] or [Delete All], and then enter the destination name again.

5 Confirm the entered character and press [OK].

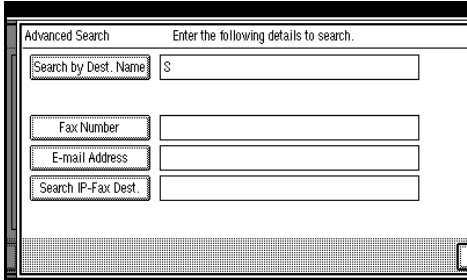

A search-in-progress message appears.

When the search is finished, a result appears.

6 Select a destination.

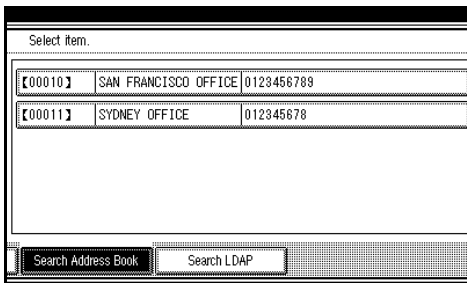

Note

- ❑ If the desired destination does not appear, use [▲] or [▼] to scroll through the list.

Search by Fax Number

1 Press , the magnifier icon.

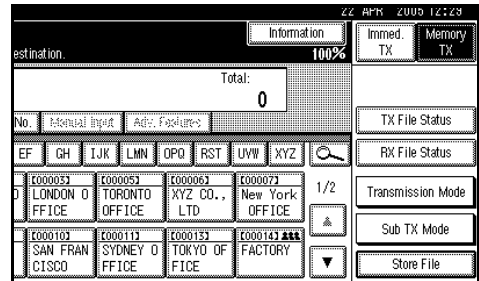

2 Press [Advanced Search].

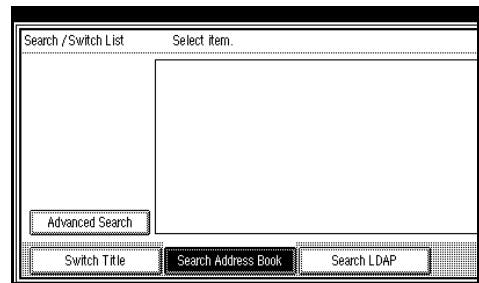

3 Press [Fax Number].

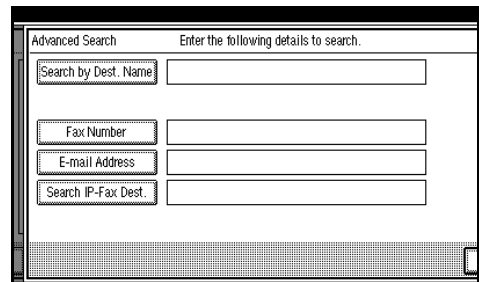

4 Enter a number to search for, and then press [OK].

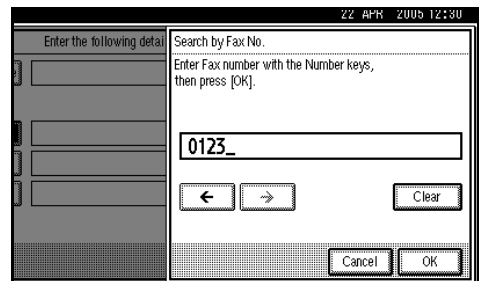

2

Note

- ❑ If you enter a wrong number, press [←] or [→] and [Clear], and then enter the number again.

5 Confirm the entered fax numbers and press [OK].

2

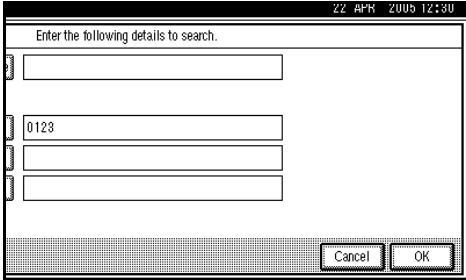

A search-in-progress message appears.

When the search is finished, a result appears.

6 Select a destination.

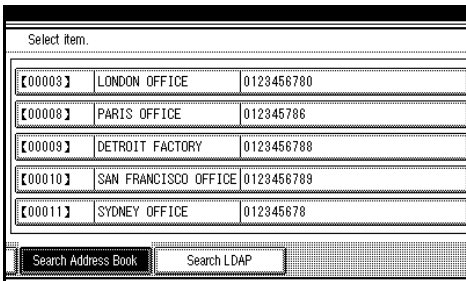

Note

- ❑ If the desired destination does not appear, use [▲] or [▼] to scroll through the list.

Search by E-mail Address

1 Press , the magnifier icon.

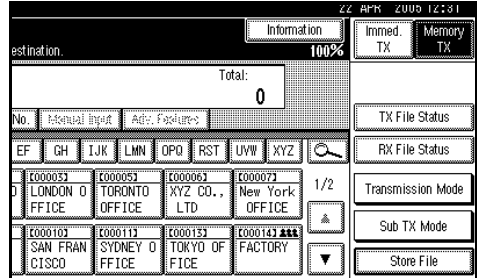

2 Press [Advanced Search].

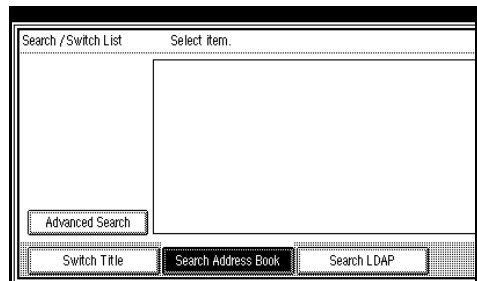

3 Press [E-mail Address].

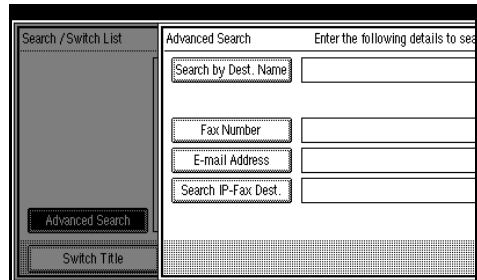

4 Enter an e-mail address to search for, and then press [OK].

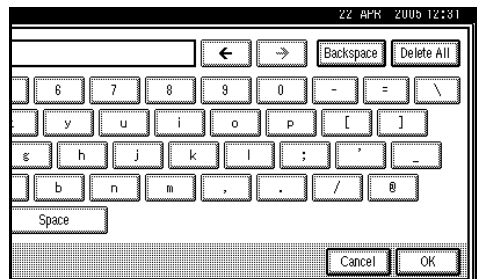

Note

- ❑ If you enter a wrong e-mail address, press [←] or [→] and [Backspace] or [Delete All], and then enter the e-mail address again.

5 Confirm the entered characters and press [OK].

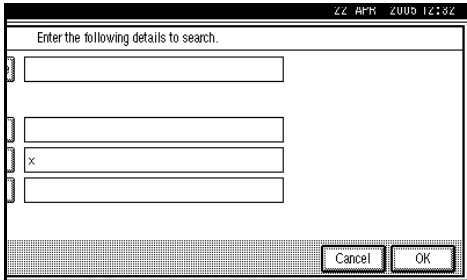

A search-in-progress message appears.

When the search is finished, a result appears.

6 Select a destination.

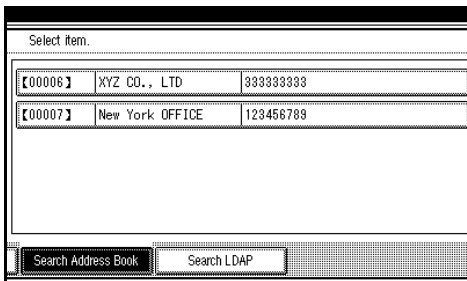

Note

- ❑ If the desired destination does not appear, use [▲] or [▼] to scroll through the list.

Search by IP-Fax Destination

1 Press the magnifier icon.

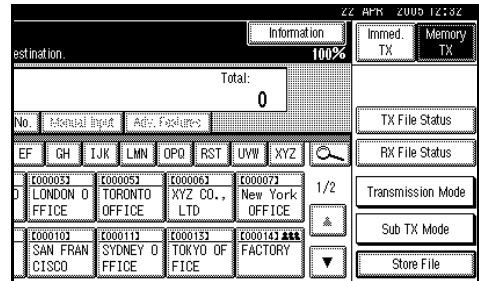

2 Press [Advanced Search].

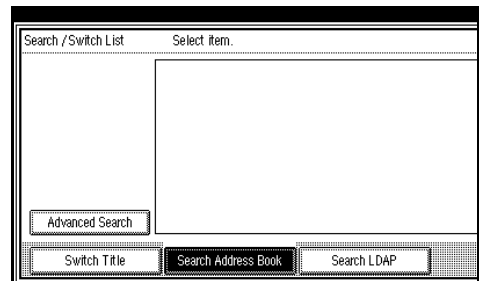

3 Press [Search IP-Fax Dest.].

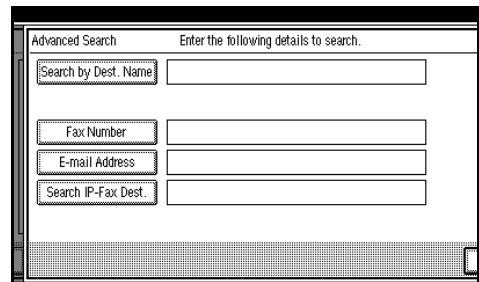

4 Enter an IP-Fax destination to search for, and then press [OK].

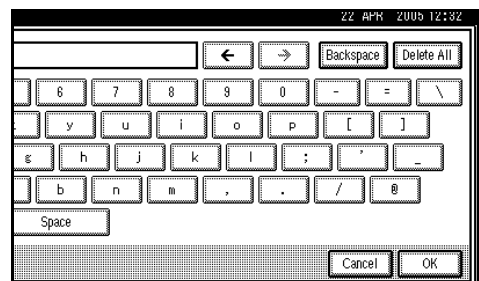

Note

- ❑ If you enter a wrong destination, press [←] or [→] and [Backspace] or [Delete All], and then enter the destination again.

5 Confirm entered IP-Fax destination and press [OK].

2

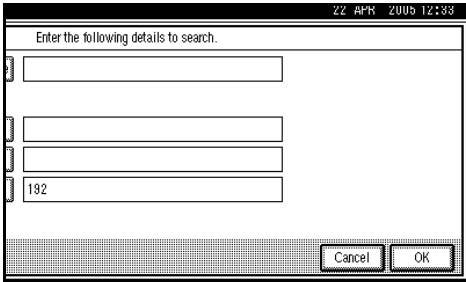

A search-in-progress message appears.

When the search is finished, a result appears.

6 Select a destination.

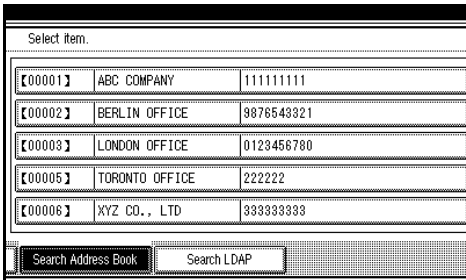

Note

- ❑ If the desired destination does not appear, use [▲] or [▼] to scroll through the list.

Search by LDAP Server

1 Press , the magnifier icon.

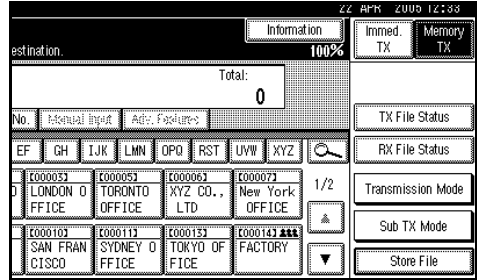

2 Press [Search LDAP].

3 Press [Select Server].

4 Select the LDAP server to search through.

Note

- ❑ LDAP servers can be programmed under System Settings. See *Network Guide* for the details.
- ❑ Make sure at least one LDAP server is highlighted. If no LDAP server is selected, an error message appears after you start searching.

5 Press [OK].

6 Press [Advanced Search].

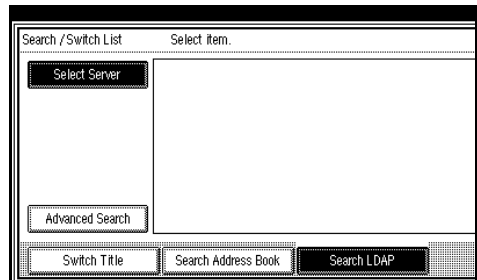

7 Enter a partial string for each search condition.

Note

- Conditions (Name, E-mail Address, Fax Number, Company Name, and Department Name) are those programmed in the LDAP server.
- Press each condition to display the entry field, where you enter the necessary information.
- You can add one additional search condition for LDAP servers by specifying the Arbitrary Search Condition under Program/Change/Delete LDAP Server under System Settings. See *Network Guide* for the details.
- The string you enter in the **[Name]** condition field is read as the first or last name, depending on the administrator's setting. For example, to search for the name "John Smith", ask the system administrator whether you should enter "John" or "Smith".

8 Press [Search Criteria] for each condition, and then select the search criteria.

Note

- The meanings of the search criteria are as follows:
 - **[Search Beginning Word]**: Search for strings that start with the specified character.
Example: When searching for "ABC", enter "A".
 - **[Search End Word]**: Search for strings that end with the specified character.
Example: When searching for "ABC", enter "C".
 - **[Exact Match]**: Search for strings that fully match the specified character.
Example: When searching for "ABC", enter "ABC".
 - **[Include One of Words]**: Search for strings that include the specified character.
Example: When searching for "ABC", enter "A", "B", or "C".
 - **[Exclude Words]**: Search for strings that do not include the specified character.
Example: When searching for "ABC", enter "D".
 - **[Fuzzy Search]**: Perform a fuzzy search (according to the searching method supported by the LDAP server).

9 Press [OK].

Note

- Although one user can program multiple e-mail addresses, only one address can be retrieved by the search. The address retrieved by the search depends on the searching method supported by the LDAP server. However, the address programmed first is normally retrieved.

- Press [Detail] to display the detailed information of the selected destination.

When the search is finished, the search result appears.

10 Select a destination.

Note

- If the required destination does not appear, press [▲] or [▼] to display it.

Specifying a Registration Number

Use this procedure to select a destination by specifying a registration number.

- 1** Press to switch the destination between fax number, e-mail address, and IP-Fax number.

- 2** Press [Registration No.].

The registration number entry display appears.

- 3** Enter a registration number using the number keys.

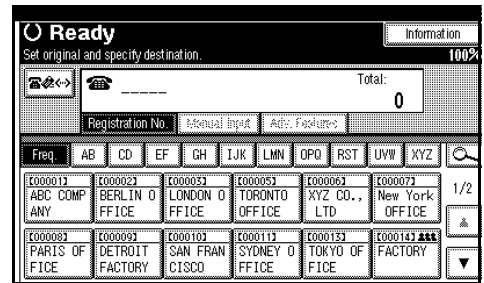

Note

- You do not need to enter the first zeros of a registration number when the display prompts you to enter five digits. If you do not enter 5 digits, press the [#] key to complete the entry.

The corresponding destination appears.

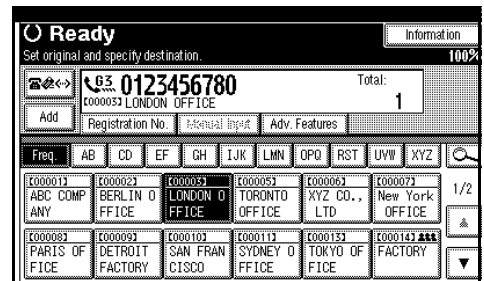

 **Note**

- The title word key switches to the destination list to which the specified destination is programmed.
- If the “Cannot find the specified Registration No.” message appears, the specified registration number is wrong. Press **[Exit]**, check the registration number again, and then follow the procedure from step **2**.
- If the “No valid destination under the specified No.” message appears, the  key is wrong. Press **[Exit]**, and then follow the procedure from step **1**.

Reception

There are two ways you can set up the machine to handle incoming calls:

- Manual Reception (external telephone required)
- Auto Reception

You can change the reception mode only if a standard G3 line is used.

You cannot change the reception mode when a line other than the standard G3 line (G3-2 or G3-3) is used.

❖ Manual Reception

When a telephone call comes in, the machine rings. If the call is a fax document, you must switch manually to facsimile mode.

❖ Auto Reception

When a telephone call comes in, the machine automatically receives it as a fax document. Use this setting on a dedicated fax line.

Note

- The external telephone is required to use this machine as a telephone.

Switching the Reception Mode

You can switch reception modes using Reception Settings in the Facsimile Features menu. See p.147 “Reception Settings”, *Facsimile Reference <Advanced Features>* .

If you program a Quick Operation key with Switch Reception Mode, you can switch the reception mode quickly.

Preparation

You can only use this function after programming a Quick Operation key as the reception mode switch with [Quick Operation Key 1], [Quick Operation Key 2], or [Quick Operation Key 3] under Gen. Settings/ Adjust. See p.145 “General Settings/Adjustment”, *Facsimile Reference <Advanced Features>* .

1 Press [Switch RX Mode].

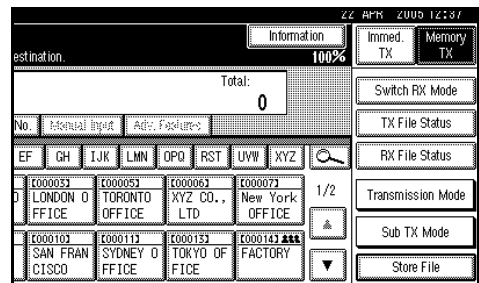

- 2 Select the reception mode, and then press [OK].

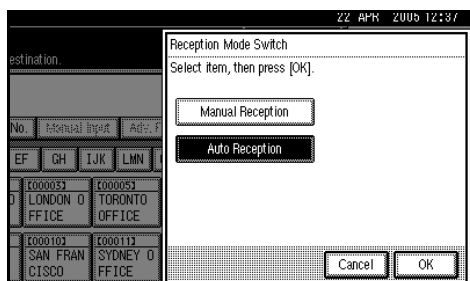

The standby display appears.

Note

- To cancel the selection, press [Cancel].

Receiving a Fax in Manual Reception Mode

- 1 When the machine rings, pick up the handset of the external telephone.
- 2 If you hear beeps, press the [Start] key or the [Start Manual RX] key. (The [Start] key is only available in facsimile mode when an original is not placed.)
- 3 Replace the handset of the external telephone. The machine will start receiving.

3. Using Internet Fax Functions

There are two types of Internet Fax function.

- Internet Fax functions. See p.55 “Internet Fax Functions (by Specifying an E-mail Address)”.
- IP-Fax function. See p.73 “Internet Fax Functions (by Specifying an IP Address)”.

Internet Fax Functions (by Specifying an E-mail Address)

The optional printer/scanner unit is required.

This machine converts scanned document images to e-mail format and transmits the data over the Internet.

The e-mail sent by this machine can be received by another Internet Fax machine. Instead of dialing the telephone number of the destination you want to send to, you enter the relevant e-mail address.

You can also print or forward received e-mail messages.

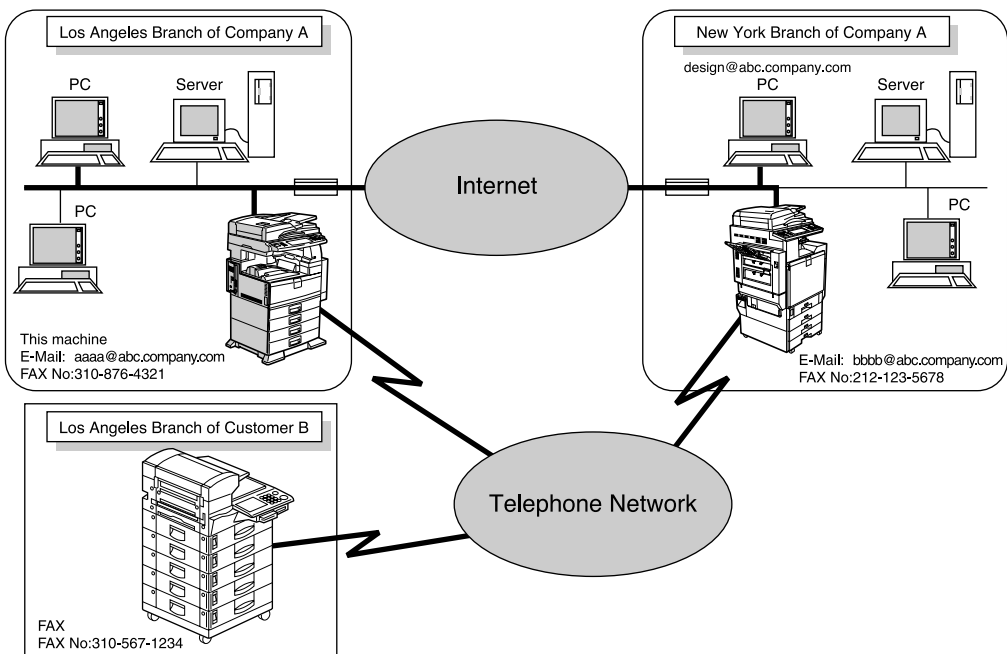

AJA002S

⚠ **Limitation**

- ❑ To send Internet Fax documents, in the Facsimile Features menu, under E-mail Settings, set **[Internet Fax Settings]** to **[On]**. However, documents can still be forwarded or delivered to Internet Fax destinations even if **[Off]** is selected.
- ❑ To receive Internet Fax documents, in the System Settings menu, in File Transfer, under **[Fax E-mail Account]**, set **[Account]** to **[Receive]**.
- ❑ This machine must be connected to a LAN and set up correctly in order to use its Internet Fax functions. See “Connecting and Setting Up”, *Network Guide*.

📝 **Note**

- ❑ The Internet Fax function supported by this machine is compliant with ITU-T Rec. T.37. See p.210 “Compatible Machines”, *Facsimile Reference <Advanced Features>* .
- ❑ You can receive e-mail messages with an attached TIFF-F image from computers.

Internet Fax Precautions

- Internet Fax communicates with a server over a LAN. It cannot communicate directly with other parties.
- When using a Transfer Request by e-mail, documents are sent at A4 width. Documents larger than A4 are reduced to A4 width. If the receiver is in compliance with the T.37 full mode, documents are sent at the width specified in the Address Book. See p.57 “T.37 Full Mode” and p.210 “Acceptable Types of Originals”, *Facsimile Reference <Advanced Features>* .
- If a transmission is not successful, this machine usually receives an e-mail error notification. See p.203 “Server-Generated Error E-mail”, *Facsimile Reference <Advanced Features>* . However, e-mail error notifications may not be transmitted for various reasons. It is recommended that you confirm receipt of important document by calling the other party.
- The level of security for Internet communications is low. It is recommended that you use the telephone network for confidential communications.
- Voice communication is not supported over a LAN.
- Internet Fax delivery might be delayed due to network congestion. Use Internet Fax transmission that bypasses the SMTP server or a public telephone line fax whenever communication time is a concern. See p.66 “Bypassing the SMTP Server”.
- If you use this machine with dial-up connection, the Auto E-mail Reception function accesses the provider's server via telephone line and may incur call charges even if you do not receive e-mail. To reduce the frequency of server access, specify a large E-mail Reception Interval. For the E-mail Reception Interval setting, see “File Transfer”, *Network Guide*.

Functions Not Supported by E-mail Transmission

The following functions are supported with standard fax transmission, but not with Internet Faxing.

- Immediate Transmission
- Confidential Transmission
- ID Transmission
- Polling Transmission
- Chain Dial
- Transmission by SUB Code
- On Hook Dial
- Manual Dial
- JBIG Transmission
- Batch Transmission
- ECM (Error Correction Mode)
- Memory File Transfer

3

Functions Not Supported by E-mail Reception

The following functions are supported with standard fax reception, but not with Internet Faxing.

- Confidential Reception
- Memory Lock Reception
- Polling Reception
- SEP Code reception
- Authorized Reception
- Reception File Print Quantity

T.37 Full Mode

This machine is T.37 full mode compatible. T.37 full mode is an international standard for Internet Fax transmission. (ITU-T announcement, RFC2532)

When an Internet Fax communication is made between T.37 full mode compatible machines, the receiver side sends the return receipt (dispatched) in response to the reception notice request attached to the sent e-mail. This return receipt includes the receiver's reception capability information (compression type, paper size, and resolution). When the receiver is programmed in the Address Book as the full mode destination, the sender side automatically registers the received information in the Address Book. This allows you to send a subsequent Internet Fax document to that receiver based on this information.

 **Note**

- ❑ If you program a destination in the Address Book using Web Image Monitor, program the T.37 full mode supporting machine as the T.37 full mode destination. See p.125 “Programming Destination Information from Web Browser”, *Facsimile Reference <Advanced Features>* .
- ❑ If you use Internet Fax transmission, you can send documents to multiple destinations at once. However, if you specify full mode destinations, since each destination may have a different reception capability, transmission is done one by one in the specified transmission order.

3**❖ Returning a Return Receipt**

When an e-mail is received, if the sender requests reception notice, the receiver sends a return receipt that includes the receiving machine's capability (compression type, paper size, and resolution).

❖ Registering the Received Reception Confirmation Contents

When the sender receives the return receipt that includes the receiver's reception capability, the sender checks that the final recipient address sent is programmed in the Address Book. If it is programmed as a full mode destination, the sender automatically registers the receiver's reception capability. The registered reception capability is updated each time the sender receives new reception capability information. The sender can send documents to the receiver based on this information.

❖ Requesting a Reception Notice

When the receiver's machine supports T.37 full mode and is programmed as a full mode machine in the Address Book, the machine requests the reception notice from the receiver. Then, the machine will receive the return receipt (sent) that includes the receiver's reception capability.

 **Note**

- ❑ If the receiver is programmed as the simple mode machine or not programmed in the Address Book, the receiver's reception capability cannot be registered.
- ❑ If you know the receiver's reception capability, you can set it manually. However, this setting is overwritten when the machine receives the return receipt. See p.125 “Programming Destination Information from Web Browser”, *Facsimile Reference <Advanced Features>* .

Sending Internet Fax Documents

You can send Internet Fax documents only by Memory Transmission. If you specify Immediate Transmission in Internet Fax, the mode is switched to Memory Transmission when one e-mail address or more is specified.

Preparation

Before using this function, the following preparations are required:

- Make the network settings in the System Settings menu. See “Setting Up the Machine on a Network”, *Network Guide*.
- Program the sender to the destination list and set “Use Name as” to “Sender”. See “Fax Destination”, *General Settings Guide*.

When sending documents, you can set e-mail options using [Sub TX Mode].

You can set the following options:

❖ Enter Subject

Allows you to enter a subject for the document you want to send.

Note

- For convenience, program frequently-used subjects. “[Urgent]”, and “[High]” are programmed as default. See “Connecting and Setting Up”, *Network Guide*.
- You can enter up to 128 characters in total.
- If you send e-mail without setting a subject/text in “E-mail Options” under “Sub TX Mode”, a subject is automatically inserted. For details about how the subject is automatically inserted, see p.65 “About the E-mail Subject” and p.72 “Received Images”.
- You cannot send a subject only as e-mail without an original.

❖ Enter Text

Allows you to enter the text to be transmitted.

Note

- To enter text, program it beforehand. See “Connecting and Setting Up”, *Network Guide*.
- You cannot send text only without an original.

❖ Reception Notice

You can confirm sent documents were properly received using e-mail or the Journal.

❖ BCC Transmission

E-mails are sent to all specified destinations as bcc.

Important

- If a power outage lasts about an hour, or the machine is disconnected from the power outlet for about an hour, documents stored in the fax machine's memory are deleted. If any document is deleted, the Power Failure Report is automatically printed out when the main power switch is turned on. Use this report to check which documents were deleted. Simply turning off the power by pressing the Operation switch does not delete stored documents. See p.202 “Turning Off the Main Power / In the Event of Power Failure”, *Facsimile Reference <Advanced Features>*.
- You may not be able to send large files as e-mail, depending on e-mail environment conditions.
- The level of security for Internet communications is low. Use of the telephone network is recommended for confidential communications.

Limitation

- When available memory is low, you may not be able to send Internet Fax documents.

Note

- Because the machine sends documents as e-mail messages with an attached TIFF-F image, viewer applications are required in order to view documents when they are received on a computer.
- You can limit the size of transmitted e-mail messages in "E-mail Settings" of "Facsimile Features". See p.148 "E-mail Settings", *Facsimile Reference <Advanced Features>*.
- See p.72 "Received Images" for how e-mail is actually received by the computer when it is sent with mail options selected.
- If you send Internet Fax documents specifying a user code, and the e-mail address is set as the routing destination of the specified user code, a Communication Result Report is sent after the transmission is completed. This makes it possible to verify the result of a transmission.
- For details about how to confirm the transmission result, see p.27 "Confirming Transmission".
- You can specify fax destination and Internet Fax destination simultaneously.
- You cannot send e-mails to a destination as cc.

1 Press to switch the destination to e-mail address.

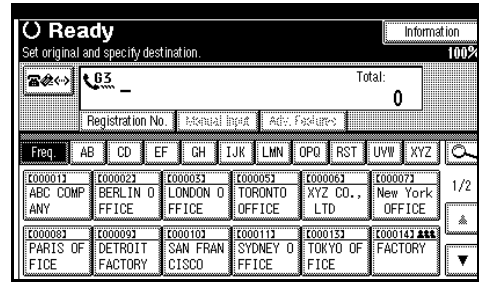

2 Specify the sender.

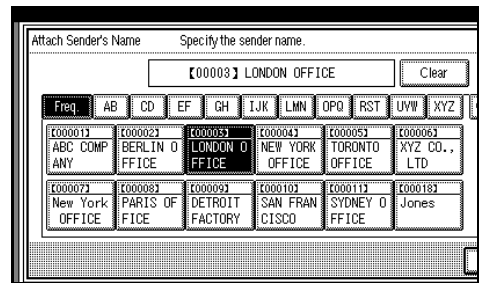

Reference

p.5 "Sender Settings", *Facsimile Reference <Advanced Features>*

Note

- If "Auto Specify Sender Name" is set to "On", the sender is automatically specified and you can omit the procedure for specifying a sender. If "On" is selected, the specified e-mail address is printed at "From:". If no e-mail address is specified for the sender, or if the specified e-mail address is not programmed in the destination list, Internet Fax documents cannot be sent. See "File Transfer", *Network Guide*.

3 When you set an e-mail option, press [Sub TX Mode].

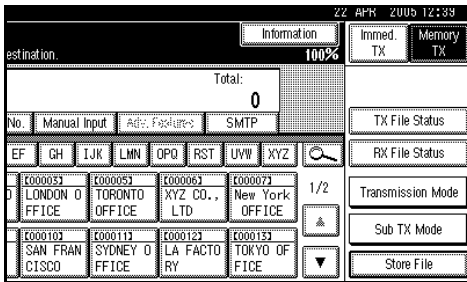

If you are not setting e-mail options, proceed to step 7.

4 Press [E-mail Options].

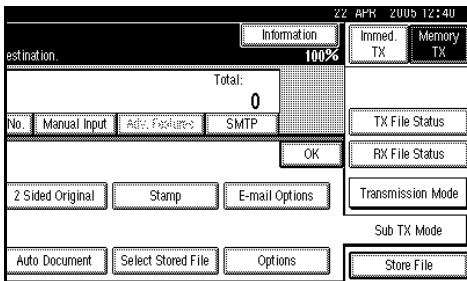

To enter the subject

1 Press [Change] for Enter Subject.

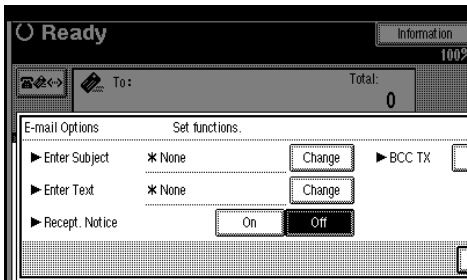

There are two methods of entering a subject: Selecting from programmed subjects, or entering characters directly. If you are entering characters, proceed to step 3.

2 Select the subject from the displayed list.

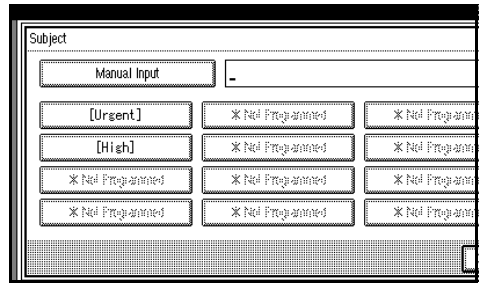

The selected subject appears in the manual input column.

3

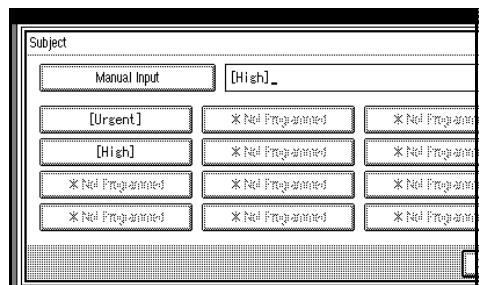

Note

- You can enter extra characters after the selected subject. If you do not need to enter extra characters, proceed to step 5.

3 Press [Manual Input].

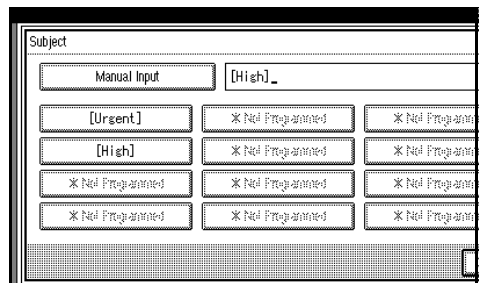

- 4 After entering the subject, press [OK].

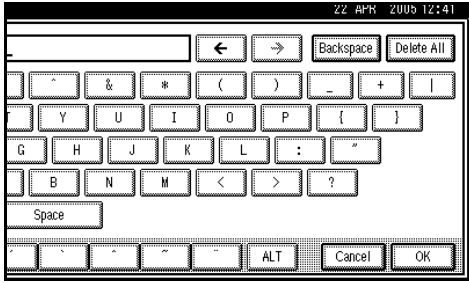

Reference

“Entering Text”, *General Settings Guide*

Entered characters appear in the manual input column.

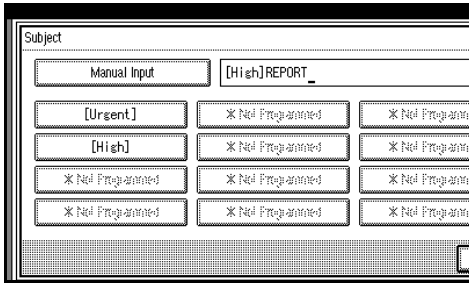

Note

- You can add a programmed subject after the entered subject. Select the subject from the displayed subjects.

- 5 Press [OK].

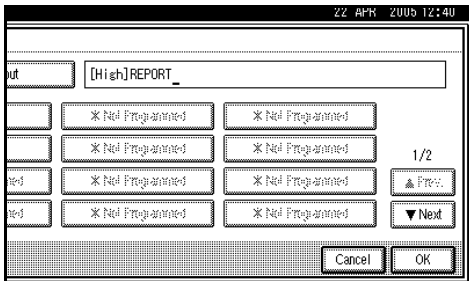

To enter the text

- 1 Press [Change] for Enter Text.

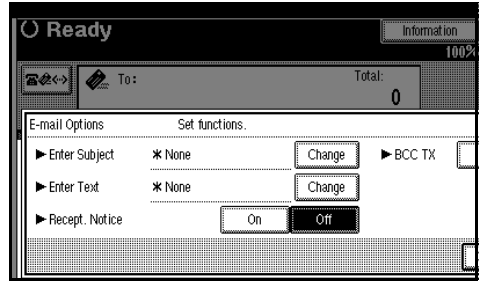

- 2 Select a text, and then press [OK].

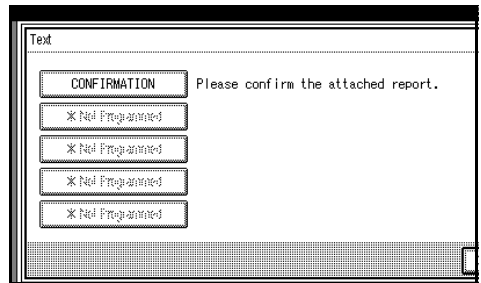

To set reception notice

- 1 Select [On] or [Off] for Recept. Notice.

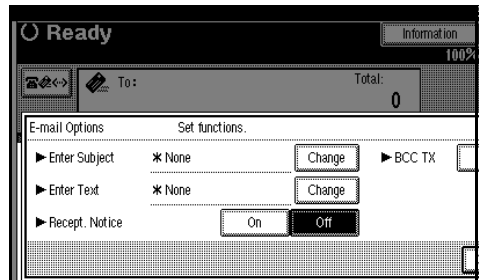

Reference

p.67 “Confirming Reception”

To set BCC transmission

1 Select [Yes] or [No] for BCC TX.

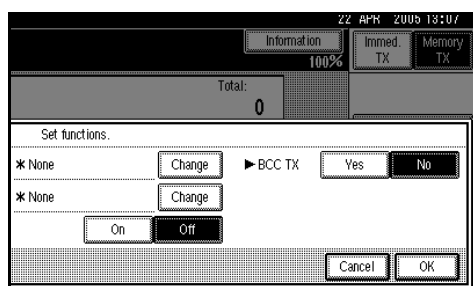

5 Press [OK].

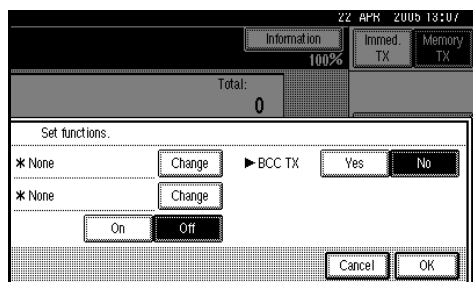

6 Press [OK].

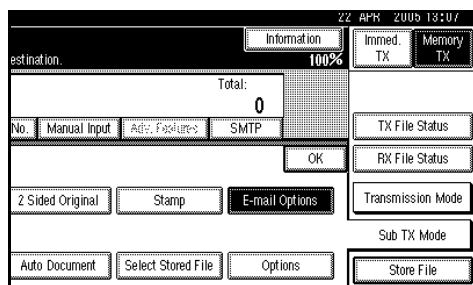

7 Place the original.

Note

- Place the original in the same manner as a standard fax. See p.11 "Placing Originals".
- Use any method to place the original, and then press the **[Start]** key.

Reference

p.11 "Placing Originals"

8 Select the scan settings you require.

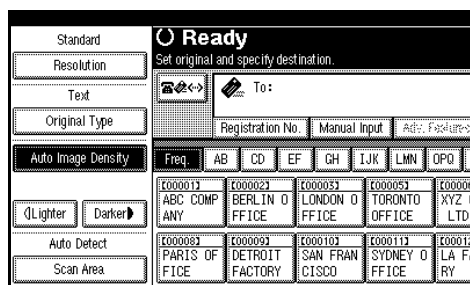

Note

- When using Internet Fax transmission, documents are sent at "Detail" resolution, even if you specify "Super Fine". To send documents at "Super Fine", specify this resolution when registering the destination in the Address Book. See p.57 "T.37 Full Mode".

Reference

p.30 "Resolution"

p.31 "Original Type"

p.32 "Image Density (Contrast)"

9 Enter the e-mail address.

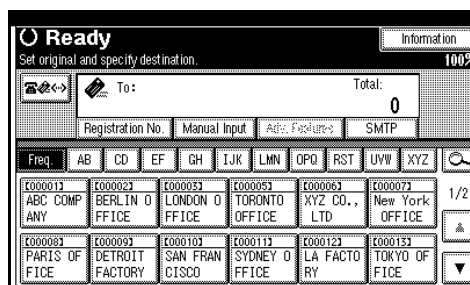

If there is only one destination, proceed to step 12.

Reference

- p.37 "Entering an E-mail Address"
- p.41 "Using the Destination List to Specify Single or Group Destinations"
- p.48 "Search by LDAP Server"
- p.47 "Redial", *Facsimile Reference <Advanced Features>*

3

10 To send the same document to multiple destinations, press [Add].

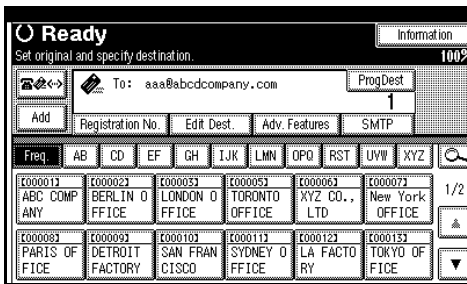

Note

- It is not necessary to press [Add] when adding destinations using the destination list.
- To be extra sure a destination is added, in User Parameters you can set the machine so that [Add] must be pressed each time a destination is added. See p.167 "User Parameters", *Facsimile Reference <Advanced Features>* (switch 17, bit 2).

11 Specify the next destination.

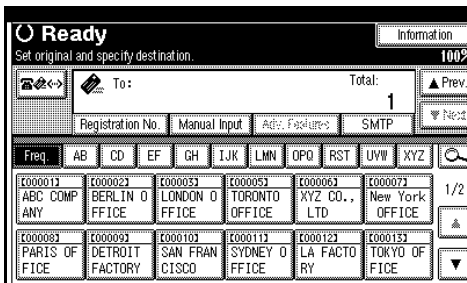

Note

- Pressing switches the destination list between fax number, e-mail address, and IP-Fax number.
- To add another destination, repeat steps 10 and 11.

12 Press the [Start] key.

This starts reading the document into memory. The e-mail send operation starts after the read operation is complete. When scanning is complete, the Communicating indicator lights and transmission starts.

Note

- With a large volume of document, it may take some time before transmission starts. This is due to the time the machine requires to convert the data in memory.
- To cancel transmission of an Internet Fax, see p.68 "Canceling Transmission of an Internet Fax".

About the E-mail Subject

If you send an e-mail without specifying a subject, a subject is automatically inserted. Subjects differ depending on Stamp Sender Name settings. See p.5 “Sender Settings”, *Facsimile Reference* <*Advanced Features*> .

❖ When Stamp Sender Name is set to [On]:

From Stamp Sender Name(Fax Message NO.xxxx)

❖ When Stamp Sender Name is set to [Off]:

- If Own Fax Number and Own Name are programmed:
From “Own Fax Number”(“Own Name”)(Fax Message NO.xxxx)
- If only Own Fax Number is programmed:
From “Own Fax Number”(Fax Message NO.xxxx)
- If only Own Name is programmed:
From “Own Name”(Fax Message NO.xxxx)
- If neither Own Fax Number nor Own Name are programmed:
Fax Message NO.xxxx

Note

- “xxxx” is the document number that appears in the Journal.

Reference

p.76 “Selecting transmission options for a single transmission”, *Facsimile Reference* <*Advanced Features*>

E-mail Text

When Internet Fax e-mail is sent to computer, the following information is always inserted in the e-mail text. To check the host name and e-mail address, see “Setting Up the Machine on a Network”, *Network Guide*.

This e-mail was sent from “Host Name” (product name)

Queries to: “Administrator's e-mail address”

Bypassing the SMTP Server

You can send Internet Fax documents directly to their destinations without going through the SMTP server. Internet Faxes are normally transmitted via the SMTP server. However, with this feature the domain part of the destination's e-mail address is read as the SMTP server's address and transmissions bypass the SMTP server. Since this reduces load on the server, you can send faxes without having to take server to destination transfer time into account.

Preparation

Set the port number for the SMTP server to 25 in advance. See "File Transfer", *Network Guide*.

Limitation

- ❑ To use this function, the other party's fax machine must be:
 - compatible with Internet Fax
 - connected to the same LAN as this machine
 - have its reception protocol set to SMTP
- ❑ SMTP authentication set on the other party's fax machine is disabled when Internet Fax is transmitted using this function.
- ❑ If an Internet Fax is transmitted from the other party using this function, even if reception is not successful, an Error Mail Notification is not sent to the sender.
- ❑ When an Internet Fax is transmitted using this function, even if transmission is not successful, the error e-mail is not sent from the server.
- ❑ When using this function, you cannot send Internet Fax documents to the administrator's e-mail address programmed on this machine.

Note

- ❑ When you specify destinations directly using the keypad, you can specify whether or not to use the SMTP server for each destination.
- ❑ When you select destinations in the destination list, the SMTP server setting specified in the Address Book is enabled.
- ❑ To send Internet Fax documents from a computer, use the LAN-Fax Driver to specify whether or not to bypass the SMTP server. When sending with the **[Use device address]** check box selected, the SMTP server setting specified on this machine is enabled. See p.112 "Basic Transmission", *Facsimile Reference <Advanced Features>*.

1 Press [SMTP].

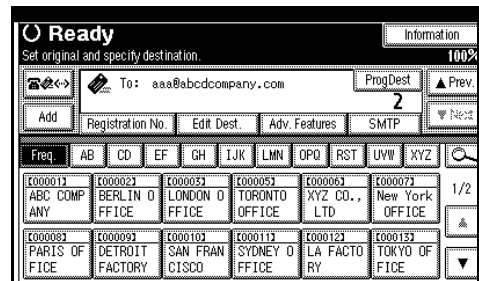

2 Press [No].

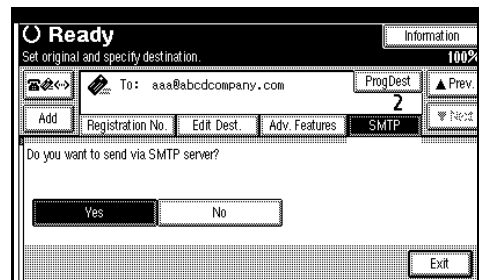

3 Press [Exit].

Confirming Reception

When Reception Notice is set under "E-mail Options", the receiver sends back a reception notice message. Once the reception notice message is received, "OK" appears in the Result column of the Journal, allowing the originator to verify the transmission was received.

Limitation

- The Reception Notice feature is only available if the receiver supports MDN (Message Disposition Notification).

Note

- If the fax is not received normally, "Error" appears in the Result column.
- Information regarding the last 200 documents is recorded, but only the last 50 communications appear in the Journal. If you do not receive a reception notice message for one of the last 50 communications from the receiver's machine, you may not be able to confirm receipt using the Journal's Result column.
- If you specify mailing list addresses, do not set for Reception Notice. Otherwise, you will receive multiple reception notice messages from e-mail recipients, and the Result column will be overwritten each time a new notice message is received. However, if you receive a reception notice message indicating an error, "Error" appears in the Result column and will not be overwritten, even if you subsequently receive a reception notice message as "OK" following the error message.

- Reception notice results are only shown in the Journal. The Result column in all other files, lists, and transmission reports show "- -".
- Reception notice messages themselves are not recorded in the Journal.
- You can select whether or not to print the Reception Notice. This can be set with User Parameters. See p.167 "User Parameters", *Facsimile Reference <Advanced Features>* (switch 21, bit 0).
- You cannot broadcast e-mails using Reception Notice. The documents are sent to the destinations in the order in which they were specified.

Canceling Transmission of an Internet Fax

When fax, Internet Fax, and IP-Fax destinations are specified simultaneously, as well as only a fax or IP-Fax destination is specified, you can cancel transmission using the same method.

Note

- ❑ You cannot cancel transmission once the original is scanned.

Before the Original Is Scanned

Use this procedure to cancel a transmission before pressing the **[Start]** key.

- 1** Press the **[Clear Modes]** key.

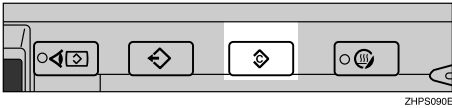

Note

- ❑ When originals are placed into the ADF, you can cancel transmission simply by removing them.

While the Original Is Being Scanned

Use this procedure to cancel a transmission after pressing the **[Start]** key.

- 1** Press the **[Clear/Stop]** key.

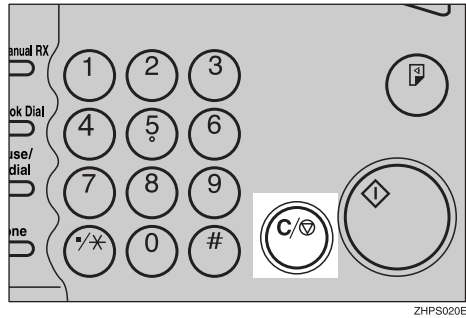

The machine stops scanning.

Note

- ❑ You can also cancel scanning by pressing **[Stop Scanning]**.
- ❑ Scanning may be completed while you are performing the cancel operation.

After the Original Is Scanned

Note

- Depending on the paper size and time when you cancel the transmission, you cannot cancel transmission of an Internet Fax.

1 Press [Change / Stop TX File].

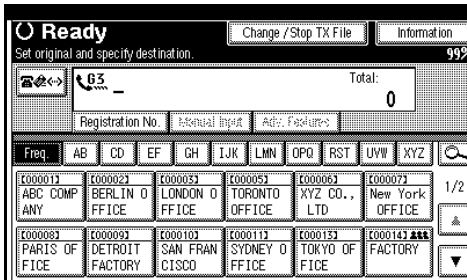

The list of stored files being transmitted or waiting for transmission appears.

2 Select the file you want to cancel.

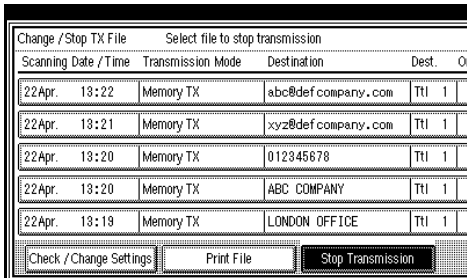

Note

- If the desired file is not shown, press [▲Prev.] or [▼Next] to find it.
- There are cases when a destination may not be selected as the destination appears as "*", depending on the security settings.

3 Press [Stop Transmission].

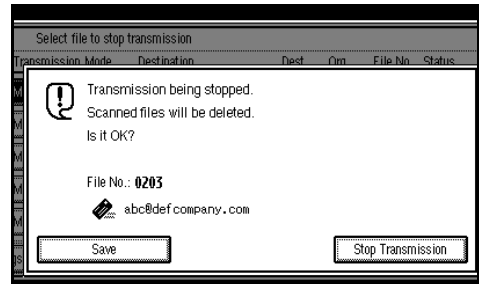

Note

- To cancel a transmission of another file(s), repeat the steps 2 and 3.
- To cancel stopping transmission, press [Save].

4 Press [Exit].

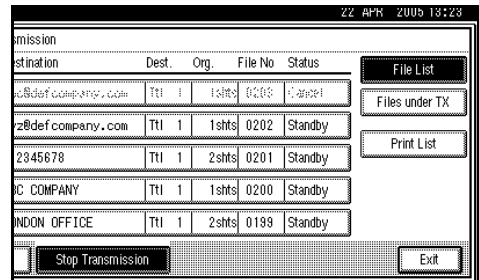

The standby display appears.

Receiving Internet Fax Documents

You can receive e-mail documents by Internet Fax.

There are two methods of receiving e-mail: Auto E-mail Reception and Manual E-mail Reception.

Limitation

- E-mail with attachments other than TIFF-F format files cannot be received. Senders receive an Error Mail Notification if their e-mail contains attachments. You can select whether or not the machine sends this message with User Parameters. See p.167 "User Parameters", *Facsimile Reference <Advanced Features>* (switch 21, bit 7). However, TIFF-F documents created by the Saving function of DeskTopBinder Professional Lite can be received.
- If "Require Secure Password Authentication (SPA) for all client connections" is selected in Windows Server 2003, reception is not possible.

Note

- When Reception Protocol is set to POP3 or IMAP4, you can set the machine to retain incoming e-mail or delete it from the server in "System Settings". See "File Transfer", *Network Guide*.
- With User Parameters, you can have the machine send the return receipt in response to the reception notice request attached to the sent e-mail. See p.167 "User Parameters", *Facsimile Reference <Advanced Features>* (switch 21, bit 1).

Auto E-mail Reception

When this function is turned on, the machine periodically checks the e-mail server for incoming e-mail and downloads it as necessary.

E-mail auto-reception should be set in "System Settings". When you select auto-reception, set the reception interval in minutes.

See "File Transfer", *Network Guide*.

Note

- If memory runs out, e-mail will not be received at the specified intervals. Reception will resume when sufficient memory becomes available.

Manual E-mail Reception

The following operation allows you to receive e-mail at all times.

Preparation

Program the Manual E-mail RX function to a Quick Operation key beforehand. See p.145 "General Settings/Adjustment", *Facsimile Reference <Advanced Features>*.

1 Press [Manual E-mail RX].

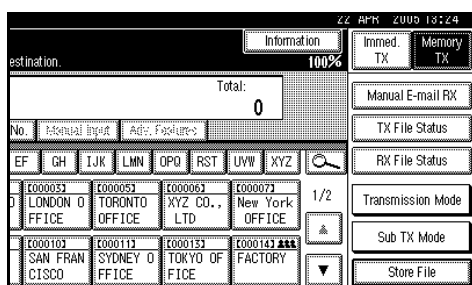

The machine accesses the server to check for e-mail and receives any new e-mails.

2 Check the message, and then press [Exit].

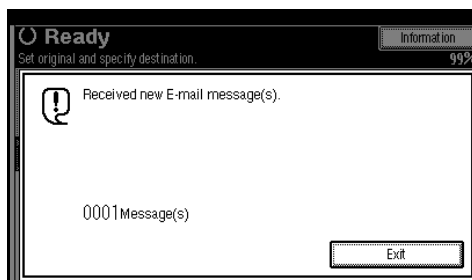

The standby display appears.

Received Images

Here is an example of an Internet Fax document sent from this machine and received on a computer using an Outlook Express e-mail application.

The received image varies according to the e-mail application.

3

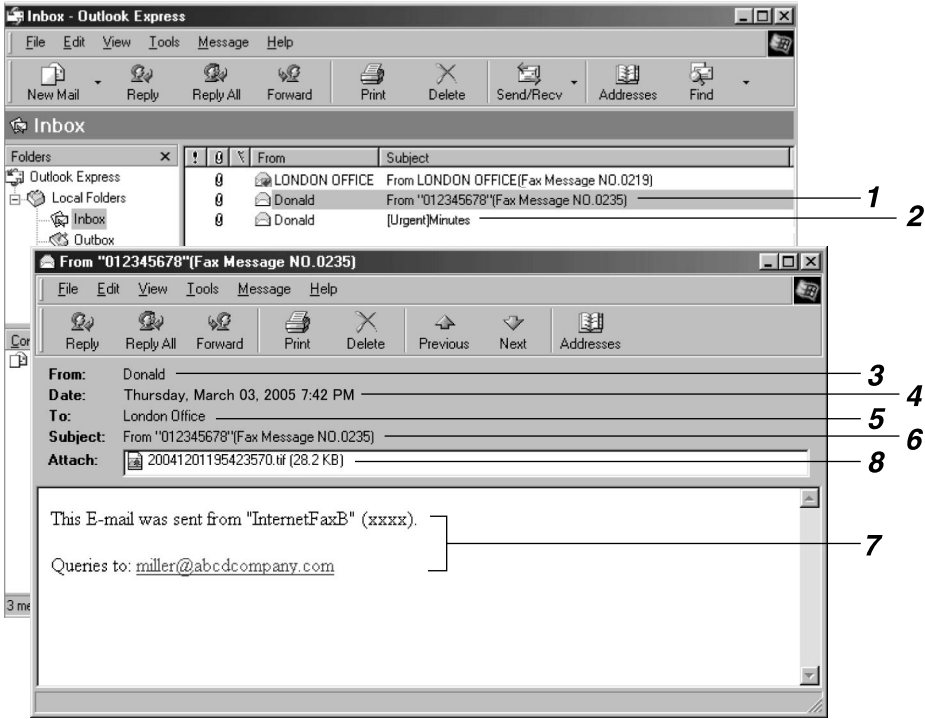

AJC004S

1. E-mail transmitted without specifying a subject in “E-mail Options”.

2. E-mail transmitted with a subject specified in “E-mail Options”.

3. From

The name (e-mail address) of the sender

Note

- The display format of the sender name differs according to that of the Stamp Sender Name setting and other functions.

4. Date

The date and time of e-mail transmission

5. To

The e-mail address of the recipient

6. Subject

Shows the subject specified in “E-mail Options” at the time of transmission. If no subject is specified, one is automatically assigned in the format shown in 1 above.

Note

- The format varies according to Stamp Sender Name and other settings. See p.65 “About the E-mail Subject”.

7. The message is inserted in all e-mails. “xxxx” is the machine name.

8. Attachment File

Any document included by the sender is displayed as an attached document.

Internet Fax Functions (by Specifying an IP Address)

The optional printer/scanner unit is required.

The IP-Fax function sends or receives documents between two facsimiles directly via a TCP/IP network. This function has the following advantages and is suitable for communication within the same LAN:

- Reducing communication costs
- Communicating between IP-Faxes at higher speed than by standard fax

IP-Fax uses SIP and H.323 as the network protocol.

Specify an IP address or host name instead of a fax number for sending. When using a gatekeeper, specify its alias telephone number. Specify addresses of the gatekeeper or SIP server (proxy server, register server, redirect server) as appropriate in IP-Fax Settings in the Facsimile Features menu. See p.150 "IP-Fax Settings", *Facsimile Reference <Advanced Features>* .

When using a SIP server, you can send by specifying SIP User Name.

You can also transmit to a G3 facsimile connected to the public switched telephone network (PSTN) via a gateway (T.38-compliant).

To cancel IP-Fax transmission, see p.21 "Canceling a Memory Transmission".

You can receive IP-Faxes in the same manner as standard faxes. See p.52 "Reception".

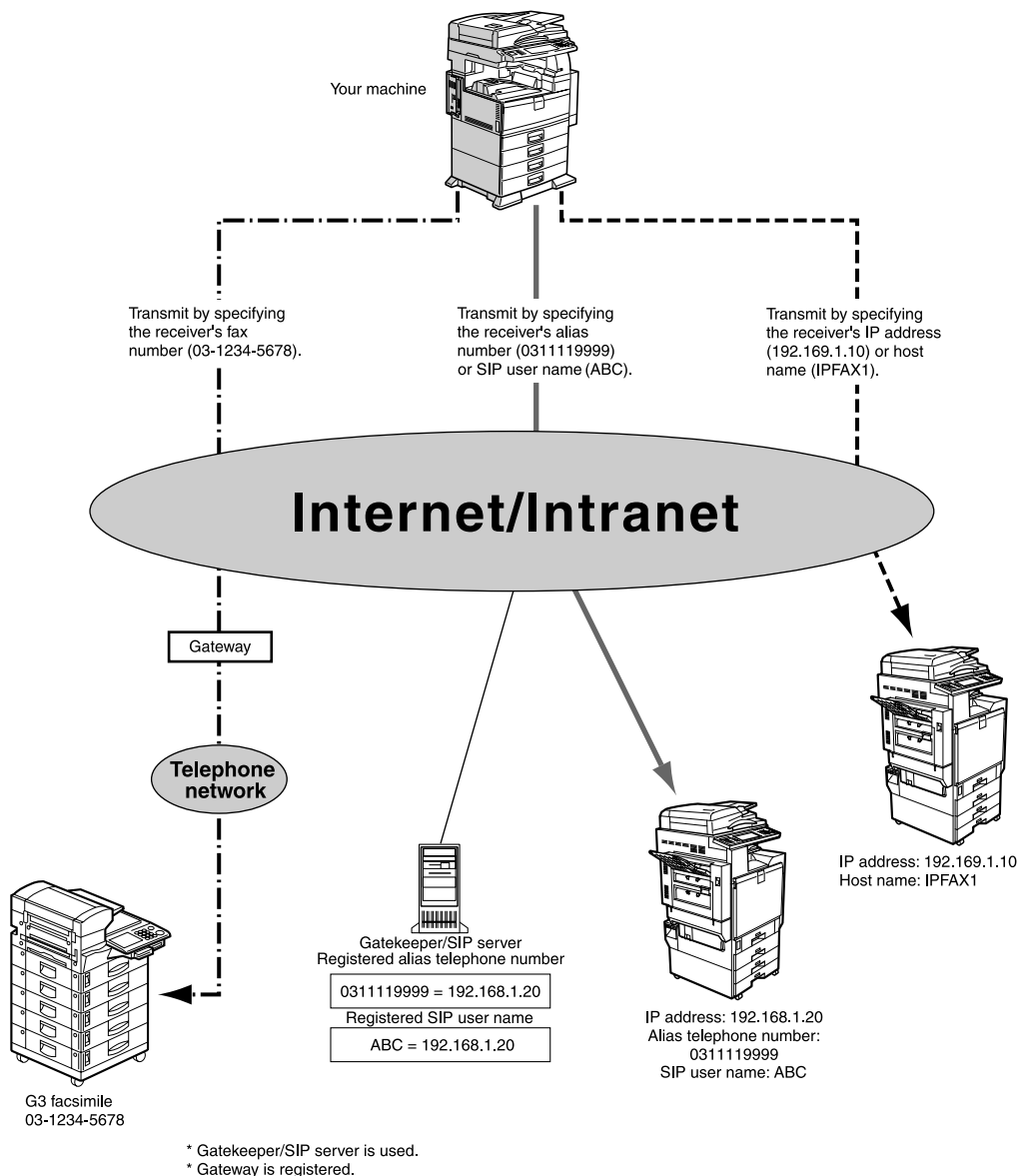

AJA003S

Note

- ❑ To use IP-Fax functions, this machine must be connected to a LAN and set up correctly under IP-Fax Settings. See p.150 "IP-Fax Settings", *Facsimile Reference <Advanced Features>* .
- ❑ IP-Fax supported by this machine is ITU-T Rec. T.38 compliant.

 **Terminology****❖ H.323**

A multimedia communication protocol that sends or receives files via one-to-one communication over a LAN or the Internet.

❖ SIP

A communication control protocol for Internet telephone that utilizes VoIP (which converts voice information to IP packets) and is equipped with functions such as creating, modifying, and terminating sessions with one or more participants.

❖ Gatekeeper (VoIP gatekeeper)

A gatekeeper manages devices connected to an IP network and converts alias telephone numbers to IP addresses and performs authentication functions. In addition, a gatekeeper governs band (transmission rate assignment) and access control.

❖ Gateway (VoIP gateway)

A gateway connecting a telephone network and IP network, it has functions such as protocol conversion for connecting these different networks, and also connects communication devices (telephones, facsimiles, etc.) to a LAN or other network.

❖ SIP server

A SIP server mediates connection requests between devices connected to an IP network and is composed mainly of servers that have the following three functions:

- Proxy server: Receives SIP requests and forwards them on behalf of the requester.
- Register server: Receives information about a device's address within an IP network and registers them in the database.
- Redirect server: Used to inquire the destination address.

Notes on Using IP-Fax

- You cannot send to a firewall-protected network.
- You cannot use telephones on a LAN.

Functions Not Available for IP-Fax Transmission

You can use the following functions with standard fax transmission, but not IP-Fax transmission:

- Batch transmission
- Manual dial

Sending by IP-Fax

IP-Fax function uses TCP/IP (LAN or Internet), and the same procedures as the standard fax function. Functions available in both standard and IP-Fax transmission can be used in generally the same manner.

By connecting the machine to a gateway (T.38-compliant), you can send to a standard G3 facsimile connected to the public switched telephone network (PSTN) via TCP/IP.

Preparation

Make the network settings in the System Settings menu beforehand. See *Network Guide*.

Note

- ❑ To send via the Internet, the receiver's machine must also be connected to the Internet. You cannot send to a firewall-protected network.
- ❑ For a list of gateways (T.38-compliant), gatekeepers, or SIP servers that are certified as operable with this machine, contact your local reseller or service provider.
- ❑ When using the transfer request function, you can specify the IP-Fax destination to the transfer station. See p.88 "Sending the Transfer Result Report", *Facsimile Reference <Advanced Features>*.
- ❑ For details about how to confirm the transmission result, see p.27 "Confirming Transmission".

- 1 Press **[IP-Fax]** to switch the destination to IP-Fax number.

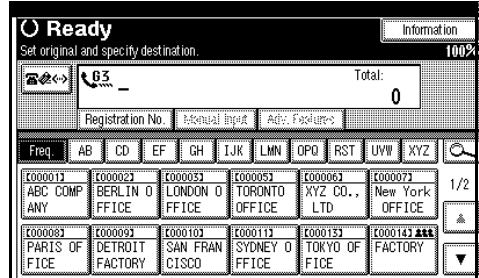

- 2 Specify the IP-Fax destination of the receiver.

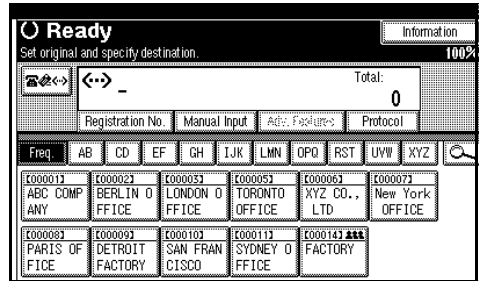

If you do not want to add a destination, proceed to step 3.

Reference

- p.38 "Entering an IP-Fax Destination"
- p.41 "Using the Destination List to Specify Single or Group Destinations"
- p.47 "Redial", *Facsimile Reference <Advanced Features>*

Note

- ❑ When both Enable H.323 and Enable SIP are set to On under IP-Fax Settings in the Facsimile Features menu, **[Protocol]** appears. Press **[Protocol]** to select the protocol you want to use.

3 To add a destination, press [Add].

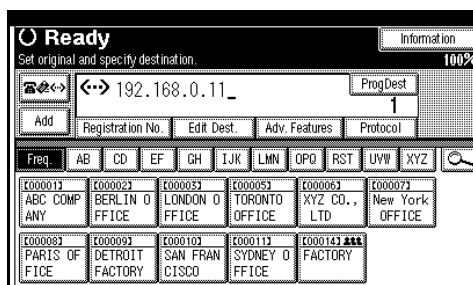

Note

- When using a destination list, multiple destinations are added automatically and you need not press [Add].
- To be extra sure a destination is added, in User Parameters you can set the machine so that [Add] must be pressed each time a destination is added. See p.167 "User Parameters", *Facsimile Reference <Advanced Features>* (switch 17, bit 2).

4 Specify the next destination.

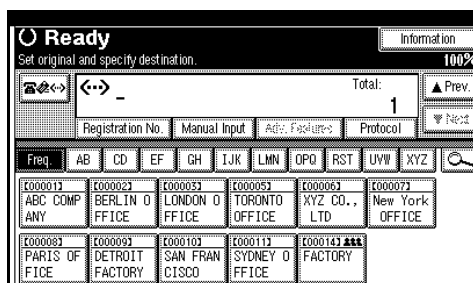

Note

- Pressing  switches the destination list between fax number, e-mail address, and IP-Fax number.
- To add another destination, repeat steps 3 and 4.

5 Press the [Start] key.

The machine starts to scan the original and stores it in memory. When scanning ends, the Communicating indicator lights and transmission starts.

4. Programming

Initial Settings and Adjustments

You can send information to the other party when transmitting or receiving a fax document. This information is shown on the display of the other machine and printed as a report. The following information can be sent.

Important

- You can confirm programmed settings from the User Parameter List. It is recommended that you print and keep the User Parameter List when you program or change settings. See p.172 "Printing the User Parameter List", *Facsimile Reference <Advanced Features>* .

❖ Fax Header

The Fax Header is printed as the header of every fax you send. You should include your name in the Fax Header.

You can program Fax Header1 or Fax Header2. When you send originals using the destination list, you can select which Fax Header is printed on the document received by the other party.

Note

- You can register up to 32 characters in the Fax Header.
- You can use characters, symbols, numbers, and spaces.
- You can set whether or not to print a Fax Header using [**Fax Header Print**] under Options . See p.74 "Fax Header Print", *Facsimile Reference <Advanced Features>* .

- In program No. 1 you can register a preference about whether or not the Fax Header is always printed. You will then switch the setting using the Fax Header Print function only when necessary. See p.130 "Registering a priority function using a program", *Facsimile Reference <Advanced Features>* .

❖ Own Name

The Own Name is sent to the other party when you send or receive a fax using a G3 line. This name should include your name. The Own Name is shown on the display of the other machine and printed in a report.

Limitation

- Own Name works only if the other machine is of the same manufacturer and has the Own Name function.

Note

- You can use characters, symbols, numbers, and spaces.
- You can register up to 20 characters as an Own Name.

❖ Own Fax Number (facsimile number of sender)

The sender's Own Fax Number is sent to the other party when sending a fax using a G3 line. The received facsimile number is shown on the display of the other machine and printed in a report. This function is available regardless of the manufacturer of the other party's machine.

Note

- You can use numbers and symbols (spaces or + sign).
- You can register up to 20 characters in Own Fax Number.

Programming

1 Press the [User Tools/Counter] key.

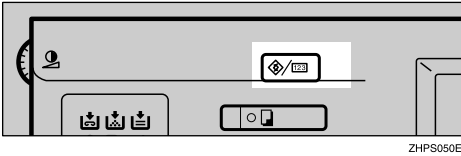

2 Press [Facsimile Features].

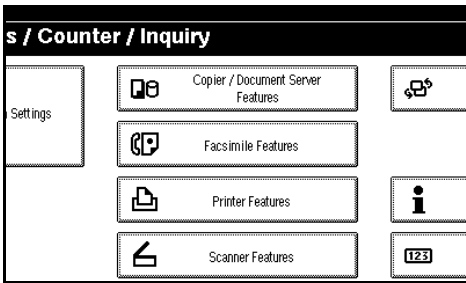

3 Make sure the [Gen. Settings/ Adjust] screen is displayed.

4 Press [Program Fax Information].

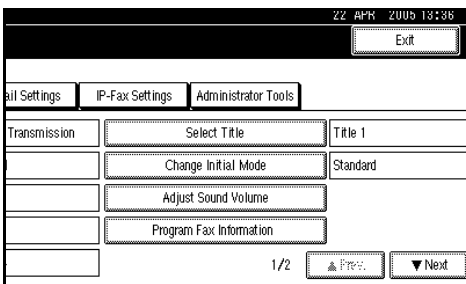

5 Program the name and facsimile number.

Programming a Fax Header

1 Press [First Name] or [Second Name].

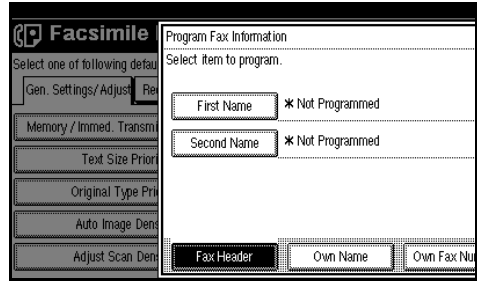

2 Enter a fax header, and then press [OK].

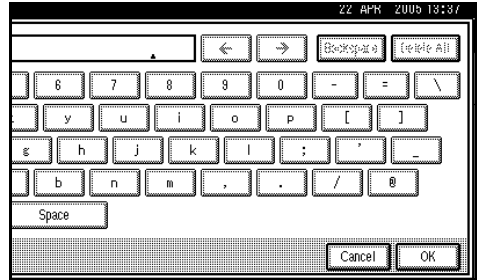

Reference

“Entering Text”, *General Settings Guide*

Programming an Own Name

1 Press [Own Name].

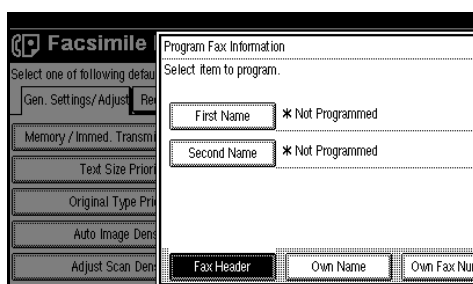

2 Press [Own Name].

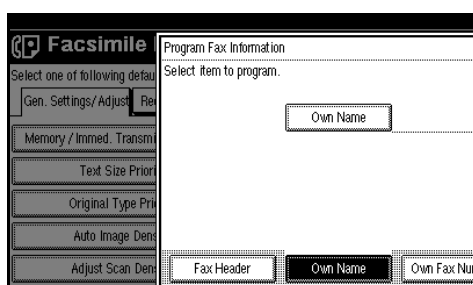

3 Enter an own name, and then press [OK].

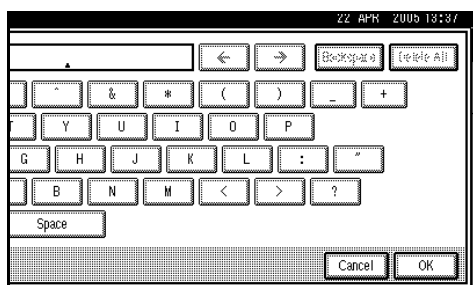

Reference

"Entering Text", *General Settings Guide*

Programming an Own Fax Number

1 Press [Own Fax Number].

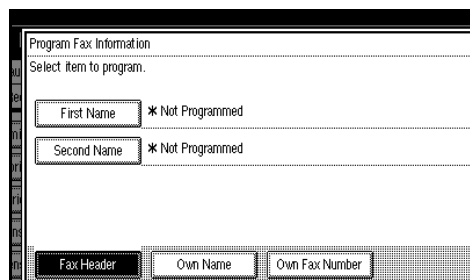

2 Select line type to program.

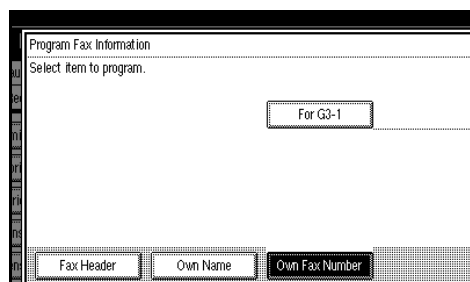

Note

- The display differs depending on the optional units installed on the machine.

3 Enter your own facsimile's number using the number keys, and then press [OK].

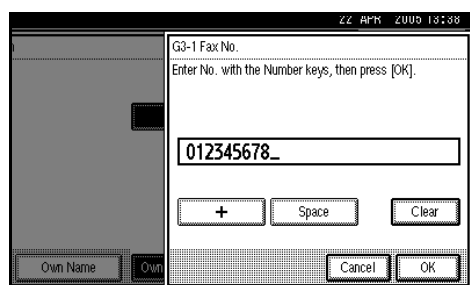

Note

- To enter a + sign or a space, press [+] or [Space].
- If you make a mistake, press [Clear] or the [Clear / Stop] key, and then enter the facsimile number again.

6 Press [Exit].

7 Press the [User Tools/Counter] key.
The standby display appears.

Editing

Note

The following procedure explains how to edit Own Name, as an example of editing.

1 Press the [User Tools/Counter] key.

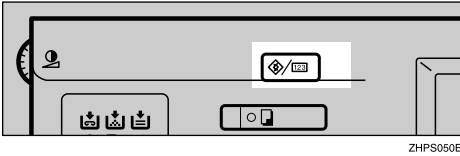

ZHPS050E

2 Press [Facsimile Features].

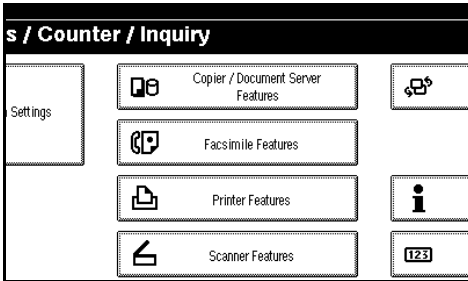

3 Make sure the [Gen. Settings/ Adjust] screen is displayed.

4 Press [Program Fax Information].

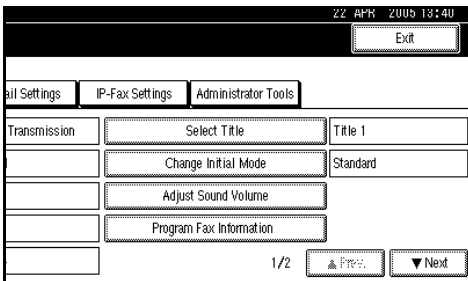

5 Press [Fax Header], [Own Name], or [Own Fax Number] to edit.

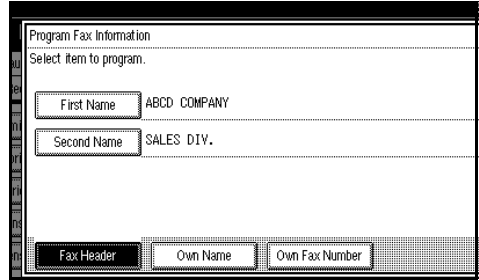

6 Press the item you want to edit.

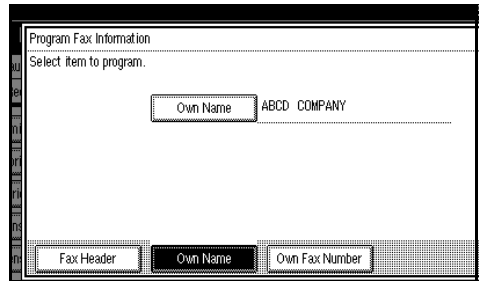

7 Press [Backspace] or [Delete All], and then re-enter the name or number.

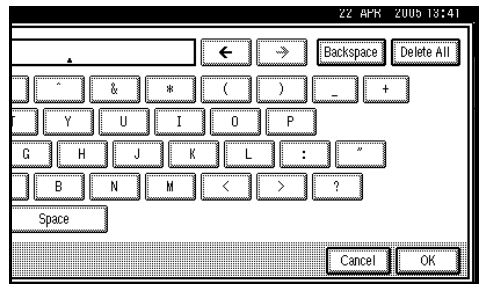

Note

When specifying your own facsimile's number, press [Clear] or the [Clear/Stop] key, and then try again.

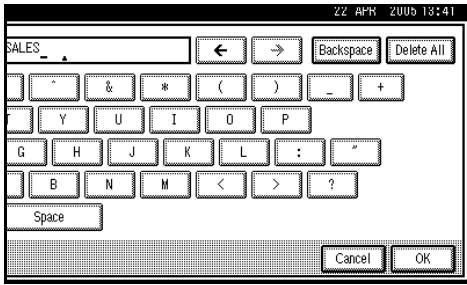
8 Press [OK].**Note**

- When specifying your own facsimile's number, press [OK].

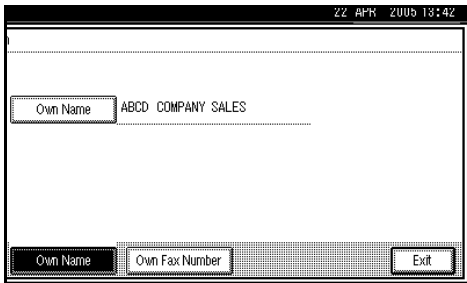
9 Press [Exit].**10** Press the [User Tools/Counter] key.
The standby display appears.**Deleting****Note**

- The following procedure explains how to delete Own Name, as an example of deleting.

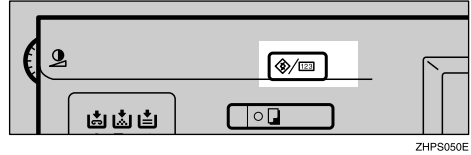
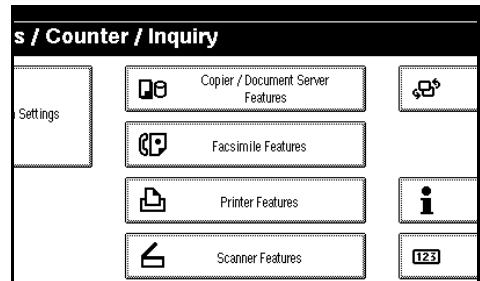
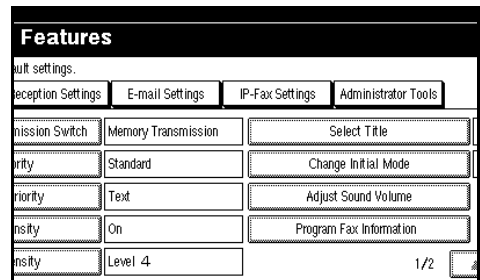
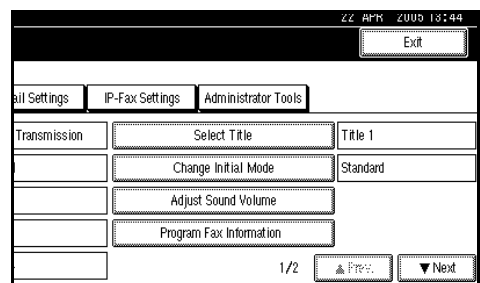
1 Press the [User Tools/Counter] key.**2** Press [Facsimile Features].**3** Make sure the [Gen. Settings/ Adjust] screen is displayed.**4** Press [Program Fax Information].

5 Press **[Fax Header]**, **[Own Name]**, or **[Own Fax Number]** to delete.

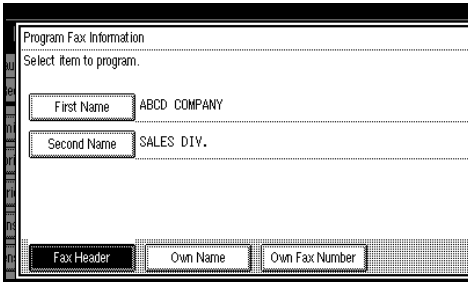

6 Press the item you want to delete.

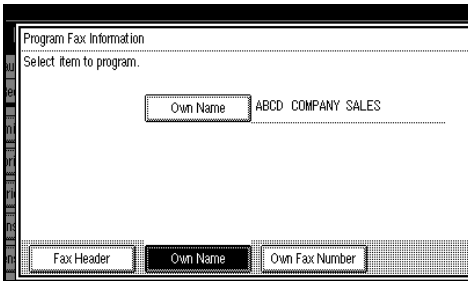

7 Press **[Backspace]** or **[Delete All]**, and then press **[OK]**.

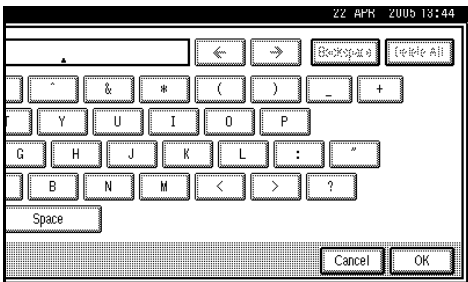

Note

- When deleting your own facsimile's number, press **[Clear]** or the **[Clear/Stop]** key, and then press **[OK]**.

8 Press **[Exit]**.

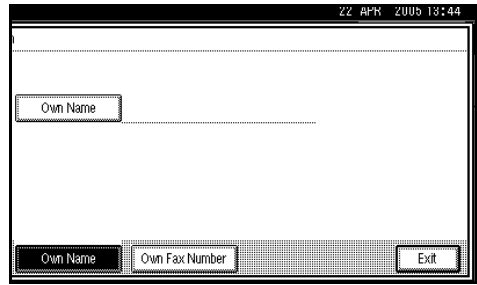

9 Press the **[User Tools/Counter]** key. The standby display appears.

Programming Destinations in the Address Book

You can program fax numbers, e-mail addresses, IP-Fax numbers, and folder destinations using Address Book Management in Administrator Tools in the System Settings menu. You can also register programmed fax numbers, e-mail addresses, IP-Fax numbers, and folder destinations in a Group.

Note

- When you press the **[Facsimile]** key to show the facsimile initial display after changing the contents of the Address Book, the “Destination list / machine settings are updated.” message appears. Press **[Exit]** to bring up the facsimile's initial display.
- You can register in the Address Book using Web Image Monitor or SmartDeviceMonitor for Admin. For details about installation, see “Monitoring and Configuring the Printer”, *Network Guide*, or, for information about the Address Book, see the relevant Help.

Reference

“Fax Destination”, *General Settings Guide*

“E-mail Destination”, *General Settings Guide*

“Registering Names to a Group”, *General Settings Guide*

5. Troubleshooting

Adjusting the Volume

You can change the volume of the following sounds that the machine makes.

❖ On Hook Mode

Heard when the **[On Hook Dial]** key is pressed.

❖ At Transmission

Heard when the machine sends a document.

❖ At Reception

Heard when the machine receives a document.

❖ At Dialing

Heard after pressing the **[Start]** key, until the line connects to the destination.

❖ At Printing

Heard when a received document is printed. See p.97 "Print Completion Beep", *Facsimile Reference <Advanced Features>* .

Note

- ❑ You can adjust the On Hook volume when you press the **[On Hook Dial]** key. See p.57 "On Hook Dial", *Facsimile Reference <Advanced Features>* .

- 1** Press the **[User Tools/Counter]** key.

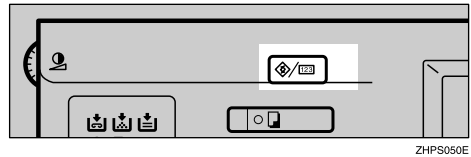

- 2** Press **[Facsimile Features]**.

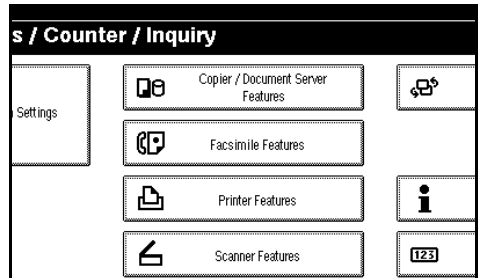

- 3** Make sure the **[Gen. Settings/ Adjust]** screen is displayed.

- 4** Press **[Adjust Sound Volume]**.

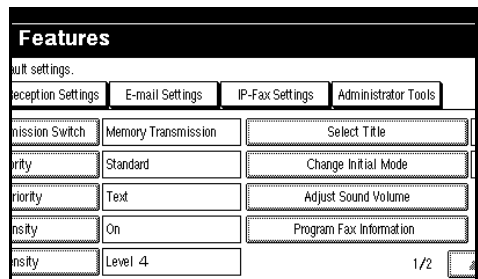

- 5** Press **[Lower]** or **[Louder]** for each item, and then press **[OK]**.

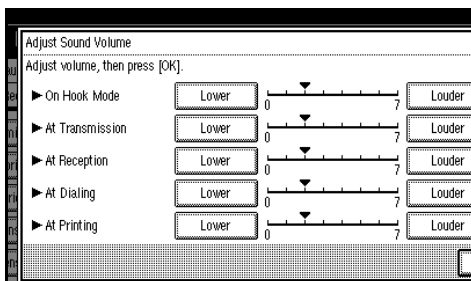

 **Note**

- You can hear the actual volume by pressing **[Check]**.
- If you press **[Cancel]**, the volume setting is canceled. The display returns to that of step **4**.

5

- 6** Press the **[User Tools/Counter]** key.
The standby display appears.

When the [Facsimile] Key Is Lit in Red

If this key is lit, press the key to enter the facsimile mode. Then, refer to the following table and take the appropriate action.

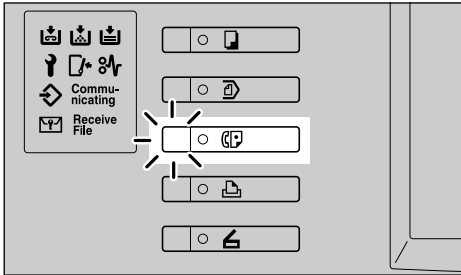

Problem	Solutions
The paper output tray is full.	Remove the paper from the tray.
A facsimile error has occurred.	The facsimile has a problem. Record the code number shown in the display and contact your service representative. See p.91 "Error Messages and Their Meanings". The copier will still function normally.
Out of paper	Add more paper. <i>"Loading Paper", General Settings Guide</i>
A network error has occurred.	<ul style="list-style-type: none"> • Check the displayed message. See p.91 "Error Messages and Their Meanings". • Check that the machine is correctly connected to the network, and that the machine is correctly set. See <i>Network Guide</i>. • Consult your network administrator. • When the key is still lit in red even if you take the measures above, contact your service representative.

When Toner Runs Out

When the machine has run out of toner, the indicator on the display lights. Note that even if there is no toner left, you can still send fax documents.

Important

- If number of communications executed after the toner has run out and not listed in the automatically-output Journal exceeds 200, communication is not possible.

Limitation

- The Memory Storage Report, Polling RX Reserve Report, and Confidential File Report are not printed.

1 Make sure that the machine is in facsimile mode.

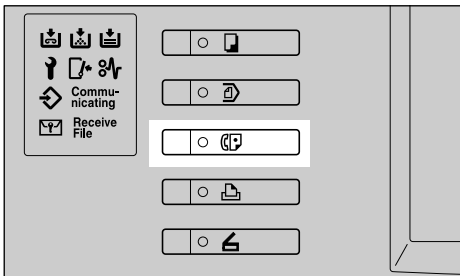

ZHPS040E

Note

- If the standby screen is not displayed, press the **[Facsimile]** key.

2 Press **[Exit]**, and then perform transmission operation.



The error message disappears.



Reference



- p.17 "Memory Transmission"
- p.24 "Immediate Transmission"



Error Messages and Their Meanings



If there is an error, one of the following messages may appear on the display. If other message appears, follow the message.



Message	Causes and solutions
You do not have the privileges to use this function.	Use of this function is restricted. Ask the administrator.
Authentication has failed.	Wrong login user name or password. Confirm correct login user name or password. Authentication is not possible from this machine. Ask the administrator.
The selected file(s) which you do not have access privileges to could not be deleted. [Exit]	You tried to delete a document for which you do not have permission to delete. Only your document administrator can delete this document. Contact your document administrator if you want to delete a document for which you do not have permission to delete.
Put original back, check it and press [Start].	Original jammed during Memory Transmission. Place originals that have not been scanned on the exposure glass or ADF again.
Error occurred, and transmission was cancelled.	A document jam occurred during Immediate Transmission. Press [OK] , and then resend the pages that have not been sent. An error occurred during Immediate Transmission. Press [OK] , and then resend the original.  Note <input type="checkbox"/> There may be a problem with the machine or the telephone line (for example noise or cross talk). If the error reoccurs frequently, contact your service representative.
Cannot detect original size. Place original again, then press [Start].	The machine failed to detect the size of the original. Place originals again, and then press the [Start] key.
 Call Service Functional problems with facsimile. Please call service.	There is a problem with the fax. Record the code number shown in the display and contact your service representative. The copy function will still work normally.
Memory is full. Cannot scan more. Transmitting only scanned pages.	If you press [Exit] , the machine returns to standby mode and starts transmitting the stored pages.
Remove the paper from Internal Tray 1.	The paper output tray is full. Remove the paper. If the other tray is also full, the tray name shown in the display changes. Remove paper from the tray indicated in the display.

Message	Causes and solutions
<p>Cannot scan to send fax message as scanner is in use for other function.</p>	<p>The Copy or Document Server function is in use. To cancel the job in process, do the following, and then try faxing again.</p> <p>Press [Exit], and then press the [Copy] or [Document Server] key. Next press the [Clear/Stop] key. When the message "[Stop] key was pressed. Stop copying?" or "[Stop] key was pressed. Stop storing?" appears, press [Stop].</p>
<p>Updating the destination list... Please wait. Specified destination(s) or sender's name has been cleared.</p>	<p>The destination list is being updated from the network using SmartDeviceMonitor for Admin.</p> <p>Depending on the number of destinations to be updated, there may be some delay before you can resume operation. Operation is not possible while this message is displayed.</p> <p>Wait until the message disappears. Do not switch off the power while this message is displayed.</p> <hr/> <p>Wait until the message disappears. Do not switch off the power while this message is displayed.</p>
<p>Check whether there are any network problems. [13-10]</p>	<p>The alias telephone number you entered is already registered on the gatekeeper by another device.</p> <ul style="list-style-type: none"> • Check that the alias telephone number is correctly programmed in IP-Fax Settings under Facsimile Features. You can also use the Web Image Monitor for confirmation. See the Web Image Monitor's Help. <p> Reference p.151 "Configuring the H.323 gatekeeper", <i>Facsimile Reference <Advanced Features></i></p> <ul style="list-style-type: none"> • Consult your network administrator.
<p>Check whether there are any network problems. [13-11]</p>	<p>Cannot access gatekeeper.</p> <ul style="list-style-type: none"> • Check that the gatekeeper address is correctly programmed in IP-Fax Settings under Facsimile Features. You can also use the Web Image Monitor for confirmation. See the Web Image Monitor's Help. <p> Reference p.151 "Configuring the H.323 gatekeeper", <i>Facsimile Reference <Advanced Features></i></p> <ul style="list-style-type: none"> • Consult your network administrator.

Message	Causes and solutions
<p>Check whether there are any network problems. [13-17]</p>	<p>Registering of user name is rejected by SIP server.</p> <ul style="list-style-type: none"> Check that the SIP server address and user name are correctly programmed in IP-Fax Settings under Facsimile Features. You can also use the Web Image Monitor for confirmation. See the Web Image Monitor's Help. <p> Reference p.151 "Configuring the SIP server", <i>Facsimile Reference <Advanced Features></i></p> <ul style="list-style-type: none"> Consult your network administrator.
<p>Check whether there are any network problems. [13-18]</p>	<p>Cannot access SIP server.</p> <ul style="list-style-type: none"> Check that the SIP server address is correctly programmed in IP-Fax Settings under Facsimile Features. You can also use the Web Image Monitor for confirmation. See the Web Image Monitor's Help. <p> Reference p.151 "Configuring the SIP server", <i>Facsimile Reference <Advanced Features></i></p> <ul style="list-style-type: none"> Consult your network administrator.
<p>Check whether there are any network problems. [14-01]</p>	<p>Cannot find the DNS server, SMTP server or folder for forwarding.</p> <ul style="list-style-type: none"> Check that the DNS server IP address is correctly programmed using Web Image Monitor. See the Web Image Monitor's Help. Check that the DNS server is correctly programmed using Web Image Monitor. See the Web Image Monitor's Help. Check that the host name or IP address of the SMTP server is correctly programmed using Web Image Monitor. See the Web Image Monitor's Help. Check that the SMTP server is correctly programmed using Web Image Monitor. See the Web Image Monitor's Help. Check that the folder for transfer is correctly specified. Check that the computer in which the folder for transfer is specified is operating correctly. Check that the LAN cable is correctly connected to the machine. See "Connecting and Setting Up", <i>Network Guide</i>. Consult your network administrator.

Message	Causes and solutions
<p>Check whether there are any network problems. [14-09]</p>	<p>E-mail transmission was refused by SMTP authentication, POP before SMTP authentication or login authentication of the computer in which the folder for transfer is specified.</p> <ul style="list-style-type: none"> • Check that the user name and password for SMTP authentication or POP before SMTP authentication are correctly programmed from File Transfer under System Settings. You can also use the Web Image Monitor for confirmation. See the Web Image Monitor's Help. <p> Reference "File Transfer", <i>Network Guide</i></p> <ul style="list-style-type: none"> • Check that the user name and password of the Fax E-mail Account are correctly programmed from File Transfer under System Settings. You can also use the Web Image Monitor for confirmation. See the Web Image Monitor's Help. <p> Reference "File Transfer", <i>Network Guide</i></p> <ul style="list-style-type: none"> • Check that the login user ID and password for the computer in which the folder for forwarding is specified are correctly programmed. • Check that the folder for forwarding is correctly specified. • Check that the computer in which the folder for forwarding is specified is correctly operated. • Consult your network administrator.
<p>Check whether there are any network problems. [14-33]</p>	<p>No machine e-mail address is programmed.</p> <ul style="list-style-type: none"> • Check that the machine e-mail address is correctly programmed from File Transfer under System Settings. You can also use the Web Image Monitor for confirmation. See the Web Image Monitor's Help. <p> Reference "File Transfer", <i>Network Guide</i></p> <ul style="list-style-type: none"> • Consult your network administrator.
<p>Check whether there are any network problems. [15-01]</p>	<p>No POP3/IMAP4 server address is programmed.</p> <ul style="list-style-type: none"> • Check that the host name or IP address of the POP3/IMAP4 server is correctly programmed using the Web Image Monitor. See the Web Image Monitor's Help. • Consult your network administrator.

Message	Causes and solutions
<p>Check whether there are any network problems.</p> <p>[15-02]</p>	<p>Cannot log on to the POP3/IMAP4 server.</p> <ul style="list-style-type: none"> • Check that the user name and password of the Fax E-mail Account are correctly programmed using File Transfer under System Settings. You can also use the Web Image Monitor for confirmation. See the Web Image Monitor's Help. <p> Reference <i>"File Transfer", Network Guide</i></p> <ul style="list-style-type: none"> • Consult your network administrator.
<p>Check whether there are any network problems.</p> <p>[15-03]</p>	<p>No machine e-mail address is programmed.</p> <ul style="list-style-type: none"> • Check that the machine e-mail address is correctly programmed using File Transfer under System Settings. You can also use the Web Image Monitor for confirmation. See the Web Image Monitor's Help. <p> Reference <i>"File Transfer", Network Guide</i></p>
<p>Check whether there are any network problems.</p> <p>[15-11]</p>	<p>Cannot find the DNS server or POP3/IMAP4 server.</p> <ul style="list-style-type: none"> • Check that the DNS server IP address is correctly programmed using Web Image Monitor. See the Web Image Monitor's Help. • Check that the DNS server is correctly programmed using Web Image Monitor. See the Web Image Monitor's Help. • Check that the host name or IP address of the POP3/IMAP4 server is correctly programmed using Web Image Monitor. See the Web Image Monitor's Help. • Check that the POP3/IMAP4 server is correctly programmed using Web Image Monitor. See the Web Image Monitor's Help. • Check that the LAN cable is correctly connected to the machine. • Consult your network administrator.

Message	Causes and solutions
<p>Check whether there are any network problems. [15-12]</p>	<p>Cannot log on to the POP3/IMAP4 server.</p> <ul style="list-style-type: none"> Check that the user name and password of the Fax E-mail Account are correctly programmed from File Transfer under System Settings. You can also use Web Image Monitor for confirmation. See the Web Image Monitor's Help. <p> Reference "File Transfer", <i>Network Guide</i></p> <ul style="list-style-type: none"> Check that the user name and password for POP before SMTP authentication are correctly programmed from File Transfer under System Settings. You can also use Web Image Monitor for confirmation. See the Web Image Monitor's Help. <p> Reference "File Transfer", <i>Network Guide</i></p> <ul style="list-style-type: none"> Consult your network administrator.

 **Out of paper display message**

If the paper tray runs out of paper, "No paper. Load it. then press [Exit]." appears on the display, asking you to add more paper.

 **Note**

- If there is paper left in the other paper trays, you can receive documents as usual, even if the message appears on the display.
- You can turn this function on or off with the User Parameters. See p.167 "User Parameters", *Facsimile Reference <Advanced Features>* (switch 05, bit 7).

 **Network error display message**



If the "Check whether there are any network problems." message appears, the machine is not correctly connected to the network or the settings of the machine are not correct. If you do not need to connect the machine to the network, in User Parameters select the message not to appear, and then the **[Facsimile]** key no longer lights. See p.167 "User Parameters", *Facsimile Reference <Advanced Features>* (switch 21, bit 6).

 **Note**

- If you reconnect the machine to the network, be sure to set "Display" with User Parameters.

Solving Problems

This table lists some common problems and their solutions.

Problem	Causes and solutions	Reference
Background of received images appears dirty. Images from the back of the page appear.	Adjust scan density.	p.32 "Image Density (Contrast)"
Printed or sent images are spotty.	The ADF or exposure glass is dirty. Clean them. Make sure that ink or correction fluid is dry before placing originals.	"Maintaining Your Machine", <i>General Settings Guide</i>
Received image is too light.	Request the sender to increase image density.	---
	When using moist, rough, or processed paper, areas of print may not be fully reproduced. Only use recommended paper.	"Copy Paper", <i>General Settings Guide</i>
	When  is blinking, toner is beginning to run out. Replace the toner cartridge soon.	"  Adding Toner", <i>General Settings Guide</i>
The machine failed to print received fax documents.	If this happened when the Receive File indicator was lit, low paper or toner levels may have caused printing to stop.	p.85 "Substitute Reception", <i>Facsimile Reference <Advanced Features></i>
	Store has been selected for Reception File Setting. Print the fax documents using a Web browser or the Print Stored RX File function.	p.124 "Printing fax information using a Web browser", <i>Facsimile Reference <Advanced Features></i> p.34 "Printing Received and Stored Documents", <i>Facsimile Reference <Advanced Features></i>
	When  is lit, load paper into the tray.	"Loading Paper", <i>General Settings Guide</i>
Document appears blank at the other end.	The original was placed upside down. Place it properly.	p.11 "Placing Originals"
Both transmission and receiving are impossible.	Make sure that the modular cord is correctly connected.	p.205 "Connecting the Machine to a Telephone Line and Telephone", <i>Facsimile Reference <Advanced Features></i>
	The setting of the terminal adaptor used for ISDN connection is incorrect. Check the setting.	---

Problem	Causes and solutions	Reference
Transmission is possible, though receiving is impossible.	The setting of the terminal adaptor used for ISDN connection is incorrect. Check the setting.	---
Receiving is possible, though transmission is impossible.	The setting of the terminal adaptor used for ISDN connection is incorrect. Check the setting.	---
	There are regions and telephone exchanges where a dial tone can not be detected. Turn the dial tone detection off in User Parameters.	p.167 "User Parameters", <i>Facsimile Reference <Advanced Features></i> (switch 22, bit 0, 1, 2)
While pressing [Manual E-mail RX] , "Cannot receive E-mails currently." appears and e-mail cannot be received.	The machine is receiving an on-demand e-mail message (e-mail inquiry from the administrator). After the e-mail is received, press [Manual E-mail RX] , and then try again.	---
When using On Hook Dial or Manual Dial, "Receiving . . ." appears and transmission is not allowed.	If the machine fails to detect the size of the original when the [Start] key is pressed, it performs a receiving operation. Press [Scan Area] , select the scan area, and then resend the document. If you use On Hook Dial or Manual Dial frequently, it is recommended that you set "Receive documents by pressing the [Start] key when originals are not set." to "Off" in User Parameters. If this is set to "Off", when using Manual Dial you cannot receive by pressing the [Start] key.	p.13 "Setting a Scan Area"
LAN-Fax Driver does not work.	The entered login user name, login password, or driver encryption key is incorrect. Check your login user name, login password, or driver encryption key, and enter them correctly.	Ask the administrator.
	A high security level is set by the extended security function. Consult your administrator about appropriate security settings.	Ask the administrator.

Problem	Causes and solutions	Reference
All fax documents stored in memory have been lost. Those documents include ones stored through Memory Transmission/Reception, Confidential Reception, Substitute Reception, or Auto Document.	When about one hour passes after power to the machine is turned off, all fax documents stored in memory are lost. If any documents have been lost for this reason, a Power Failure Report is automatically printed when the machine is turned on. If fax documents stored for Memory Transmission have been lost, check the destinations and resend the documents. If fax documents received through Memory, Confidential or Substitute Reception have been lost, ask the senders to resend the documents. If Auto Documents have been lost, reprogram them.	p.202 "Turning Off the Main Power / In the Event of Power Failure", <i>Facsimile Reference <Advanced Features></i>
Transmission failed due to "Exceeded max. E-mail size." error.	If the e-mail size specified on the machine is too large, the Internet Fax document cannot be sent. Set Max. E-mail Size to [Off] , or set the maximum e-mail size to a larger value. Then, re-send the document.	p.148 "E-mail Settings", <i>Facsimile Reference <Advanced Features></i>
When a correct password is entered, you cannot print documents that appear in the confidential box or bulletin board box, or transmit / print out stored documents.	Documents are locked by a security function if incorrect passwords are entered a certain number of times. Contact the administrator.	Ask the administrator.
[ProgDest] or [Manual Input] does not appear.	This function is made unavailable by the enhanced security function. Consult your user administrator.	Ask the administrator.
The following functions are not available: Transfer Box, Forwarding, Store File in the Information Box, routing e-mail received via SMTP, and Polling Transmission.	This function is made unavailable by the enhanced security function. Consult your user administrator.	Ask the administrator.

Problem	Causes and solutions	Reference
<p>Although a group specification was set for the following, reception was not possible.</p> <p>Receiving Station for Transfer Request, End Receiver for Transfer Box, Forwarding, Forwarding of Special Sender, Reception Report e-mail, E-mail TX Results, routing e-mail received via SMTP.</p>	<p>A maximum of 500 parties can be specified for a group. Check if there are over the specified numbers registered in the address book. If a group was registered in another group or specified as Receiving Stations 1 to 5 for the Transfer Box, transmission is canceled but an error message does not appear.</p>	<p>“Registering a Destination to a Group”, <i>General Settings Guide</i></p>

When Things Don't Go as Expected

I Want...	Operation	Reference
to cancel a Memory Transmission.	If the original is being scanned, press [Stop Scanning] or the [Clear/Stop] key.	p.21 "Canceling a Memory Transmission"
	If the original is being sent or if it is in standby, press [Change / Stop TX File] or the [Clear/Stop] key.	p.21 "Canceling a Memory Transmission" p.19 "Canceling a Transmission", <i>Facsimile Reference <Advanced Features></i>
to cancel an Immediate Transmission.	Press [Stop Transmission] or the [Clear/Stop] key.	p.26 "Canceling an Immediate Transmission"

INDEX

A

- About the e-mail subject, 65
- Adjusting the volume, 87
 - At Dialing*, 87
 - At Printing*, 87
 - At Reception*, 87
 - At Transmission*, 87
 - On Hook Mode*, 87
- Adjust Sound Volume, 87
- Advanced Search, 44
- After the original is scanned, 69
- After you have pressed the Start key, 26
- Area 1, 14
- Area 2, 14
- Auto Detect, 15
- Auto e-mail reception, 70
- Auto reception, 52

B

- BCC Transmission, 59
- Before the original is scanned, 21, 68
- Before the transmission is started, 22
- Before you have pressed the Start key, 26
- Broadcasting sequence, 20

C

- Canceling a Memory Transmission, 21
- Canceling an Immediate Transmission, 26
- Canceling transmission of an Internet Fax, 68
- Change / Stop TX File, 21, 22, 69
- Check Modes key, 3, 20
- Clear Modes key, 3
- Clear/Stop key, 4
- Communicating indicator, 4
- Communication Result Report (Memory Transmission), 28
- Confidential file indicator, 4
- Confirming by e-mail, 27
- Confirming by report, 27
- Confirming by report and e-mail, 28
- Confirming on display, 27
- Confirming reception, 67
- Confirming transmission, 27
- Control panel, 3
- CSI->Own Fax Number, 79

D

- Darker, 33
- Data In indicator, 4
- Destination key
 - Specifying a destination*, 35
- Destination list, 35, 41
- Detail, 30
- Display, 5
- Display panel, 3

E

- Edit Dest., 37, 39
- E-mail Address, 46
- E-mail Options, 61
- E-mail text, 65
- Entering a fax number, 35
- Entering an e-mail address, 37
- Entering an IP-Fax destination, 38
- Enter key (# key), 4
- Enter Text, in e-mail, 59
- Error messages and their meanings, 91

F

- Facsimile Features, 80, 87
- Facsimile key, 89
- Fax Header, 79
 - Deleting*, 83
 - Editing*, 82
 - Programming*, 80
- Faxing, 11
- Fax Number, 45
- First Name, 80
- Function keys, 4
- Functions not available for IP-Fax transmission, 75
- Functions not supported by e-mail reception, 57
- Functions not supported by e-mail transmission, 57
- Function status indicators, 4

G

- Gen. Settings/ Adjust, 80, 87
- Getting started, 3
- Groups
 - Specifying a destination*, 41

I

- Image density (contrast), 30, 32
- Immediate Transmission, 16, 24, 27
 - Canceling*, 26
- Immediate TX Result Report
(Immediate Transmission), 29
- Immed. TX, 16, 24
- Indicators, 3
- Initial settings and adjustments, 79
 - Deleting*, 83
 - Editing*, 82
 - Programming*, 80
- Internet Fax, 55
 - Bypassing the SMTP server*, 66
 - Canceling*, 68
 - Precautions*, 56
 - Receiving*, 70
 - Sending*, 59
- Internet Fax functions
(by specifying an e-mail address), 55
- Internet Fax functions
(by specifying an IP address), 73
- Internet Fax precautions, 56
- IP-Fax destination, 39

L

- Lighter, 33
- Login
 - Control panel*, 8
 - Printer driver*, 9
 - Web browser*, 9
- Log off
 - Control panel*, 9
 - Web browser*, 9
- Louder, 88
- Lower, 88

M

- Main power indicator, 4
- Manual e-mail reception, 71
- Manual E-mail RX, 71
- Manual Input, 37, 38, 61
- Manual reception, 52
- Memory Transmission, 16, 17, 27
 - Canceling*, 21
- Memory Transmission sequence, 20
- Memory TX, 16, 17
- Mixed Original Sizes, 15
- Mixing scan settings for
 - a multiple page original, 33
 - When placing originals in the optional Auto Document Feeder (ADF)*, 34
 - When placing originals on the exposure glass*, 33

N

- Names, 41
- Names of major functions, 2
- Network error display message, 96
- Notes on using IP-Fax, 75
- Number keys, 4

O

- On Hook Dial key, 4, 36
- On indicator, 3
- Operation switch, 4
- Original Type, 30, 31
- Out of paper display message, 96
- Own Fax Number, 79
 - Deleting*, 83
 - Editing*, 82
 - Programming*, 81
- Own Name, 79
 - Deleting*, 83
 - Editing*, 82
 - Programming*, 81

P

- Pause, 36
- Pause/Redial key, 4, 36
- Photo, 31
- Placing Originals, 11
- ProgDest, 35, 37, 39, 40
- Program key, 3
- Programming, 79
- Programming destinations in
the Address Book, 85
- Protocol, 39, 76

R

- Reading the display, 5
- Reading the display panel and using keys, 6
- Received Images, 72
- Receive File indicator, 4
- Receiving a fax in manual reception mode, 53
- Reception, 52
 - Auto Reception*, 52
 - Manual Reception*, 52
- Reception Notice, 59, 67
- Registering entered destinations to the Address Book, 40
- Registration No., 50
- Regular, 14
- Report
 - Communication Result Report (Memory Transmission)*, 28
 - Immediate TX Result Report (Immediate Transmission)*, 29
- Resolution, 30
- RTI->Own Name, 79

S

- Save, 22, 23, 69
- Scan Area, 14
- Scan Settings, 30
- Search by Dest. Name, 44
- Search Criteria, 49
- Searching for a destination, 44
 - Destination name*, 44
 - E-mail address*, 46
 - Fax number*, 45
 - IP-Fax destination*, 47
 - LDAP server*, 48
- Search IP-Fax Dest., 47
- Search LDAP, 48
- Second Name, 80
- Select Server, 48
- Sending by IP-Fax, 76
- Setting a scan area, 13
- SMTP, 37, 66
- Solving problems, 97
- Specifying a destination, 35
- Specifying a registration number, 50
- Stamp Sender Name, 65
- Standard, 30
- Start key, 5
- Start Manual RX key, 4, 53
- Stop Scanning, 21, 68
- Stop Transmission, 22, 26, 69
- Subject, in e-mail, 59, 65
- Sub TX Mode, 61
- Super Fine, 30, 31

- Switching between Memory Transmission and Immediate Transmission, 16
- Switching the reception mode, 52
- Switch RX Mode, 52
- Switch Title, 42

T

- T.37 full mode, 57
- Text, 31
- Text / Photo, 31
- Title 1, 41
- Title 2, 41
- Title 3, 41
- Title word key, 7
- Tone, 36
- Tone key, 4, 36
- Toner, 90
- Transmission modes, 16
- Transmissions that bypasses the SMTP server, 66
- Troubleshooting, 87
- TTI->Fax Header, 79

U

- User authentication, 8
- User Code Authentication
 - Control panel*, 8
 - Printer driver*, 8
- User Tools/Counter key, 3, 9
- Using Internet Fax functions, 55
- Using the destination list to specify single or group destinations, 41

W

- When the Facsimile key is lit in red, 89
- When things don't go as expected, 101
- When toner runs out, 90
- While the original is being scanned, 21, 68
- While the original is being transmitted, 21



Declaration of Conformity

Notice to Users in EEA Countries

This product complies with the essential requirements and provisions of Directive 1999/5/EC of the European Parliament and of the Council of 9 March 1999 on radio equipment and telecommunications terminal equipment and the mutual recognition of their conformity.

Notice to Users Accessing Analog PSTN in EEA Countries

This product is designed to be able to access analog PSTN in all EEA countries. Local PSTN compatibility is dependent on software switch settings. Please contact your service representative if relocating this product to another country. In the event of problems, please contact your service representative in the first instance.

The CE Declaration of Conformity is available by accessing the URL: <http://jboard.danka.de/jboard/produkte/index.html> and selecting the product applicable.

FAX Option Type 3045 Operating Instructions Facsimile Reference <Basic Features>

